

DEVELOPED BOILING HEAT TRANSFER: PHYSICAL MODELS, CORRELATIONS AND LINES OF FURTHER RESEARCH

Shekriladze I.G.

Department of Thermophysics,
 Georgian Technical University,
 Tbilisi, 0175,
 Georgia,
 E-mail: shekri@geo.net.ge

ABSTRACT

A keynote lecture discusses current status of research of developed boiling heat transfer. An analysis of the main experimental facts, physical models and correlations of experimental data on heat transfer coefficient (HTC) is carried out. Exclusive character of developed boiling heat transfer law resulted by control of HTC by thermodynamic conditions on nucleation sites (a model of “the theatre of director” (MTD)) is highlighted. MTD-based correlation is discussed and the results of comparison with wide experimental data on HTC during developed boiling of all types of liquids (water, organic liquids, refrigerants, cryogenic liquids, liquid metals) are presented (without dividing of liquids into groups and without matching different constants and powers to different surface-fluid combinations). Unified interpretation of developed boiling heat transfer mode and diverse specific boiling heat transfer regimes (including boiling heat transfer hysteresis) is offered based on MTD and multi-factoring concept (MFC). Finally, the ways of further research of the boiling problem are discussed.

INTRODUCTION

Complexity of boiling phenomenon is widely recognized. In this context it suffices to note that boiling takes place in a two-phase area with irregularly variable internal structure combining phase conversion with turbulent motion in a single open dissipative system. In addition, boiling heat transfer is complicated by wide diversity of cooling mechanisms functioning all together.

Complexity of boiling heat transfer inevitably requires using of physical models simplifying the phenomenon in one way or another. Unfortunately, during last decades the resistant tendency has established of extension of simplifying procedures up to exclusion from consideration of the real basic features of developed boiling heat transfer. This circumstance has posed significant problems through the choice of correct strategies of experimental investigation and interpretation of experimental

data. Below a survey of the state of art in this area of heat transfer theory is presented. Following main aspects of the problem are covered:

- Main features and experimental facts;
- MTA and MTD;
- Correlation of experimental data;
- Unified framework MTD - MFC;
- The ways of further research.

NOMENCLATURE

A	[m ²]	Heating surface area
C_p	[J/(kg·K)]	Specific heat capacity
N	-	Number of operating sites
P	[Pa]	Pressure
T	[K]	Temperature
U	[m/s]	Velocity
ΔT	[K]	Temperature difference
Q	[W/m ²]	Heat flux
q_e	[W/m ²]	Evaporative component of heat flux
K	[W/(m·K)]	Thermal conductivity
R	[kJ/kg]	Heat of evaporation
G	[m/s ²]	Acceleration of a body force
V	[m ³ /kg]	Specific volume
H	[W/(m ² ·K)]	Heat transfer coefficient
α	[m ² /s]	Thermal diffusivity
β	[radian]	Cone angle
θ	[radian]	Contact angle
ρ	kg/m ³	Density
ρ_0	[m]	Effective radius of nucleation site
τ^*	[s]	Duration of surface temperature pulsation cycle
T_i	[s]	Duration of intensive cooling effect
σ	[N/m]	Surface tension
μ	[(N·s)/m ²]	Dynamic viscosity
ν	[m ² /s]	Cinematic viscosity

Subscripts

G	Refers to vapour (fluid – without subscript)
0	Under normal gravity
S	At saturation condition
W	On the wall
Cr	Critical

MAIN FEATURES AND EXPERIMENTAL FACTS

By common agreement developed boiling means a process with decisive contribution of cooling mechanisms unique to boiling itself. Such a boiling mode is observed in rather wide range of heat fluxes between the zones with tangible effect, on one hand, of natural or forced convection and, on the other, of boiling crisis. This is why developed boiling mode may cover different ranges of heat fluxes at constant pressure depending on geometry of boiling surface, intensity of gravity field, subcooling and velocity of liquid flow. However, heat transfer law (for instance, dependence between heat flux and heating surface superheat under saturation temperature) remains uniform in all range of heat fluxes.

It also should be noted that the term "developed boiling" is established based on experimental data on boiling heat transfer on so-called commercial heating surfaces (mainly, rolled tubes). In this connection certain peculiarities of commercial surfaces also should be taken in account.

Characteristic for boiling heat transfer important feature is diversity of cooling mechanisms contributing in heat transfer.

In boiling of saturated single-component liquid one can distinguish three basic cooling mechanisms associated with boiling itself. Among them only one (micro-layer evaporation [1], Figure 1,a) is linked to immediate evaporation on boiling surface. Other two mechanisms (bubbling [2-3], Figure 1,b and jet-like [4], Figure 1,c) are linked to convection of liquid phase.

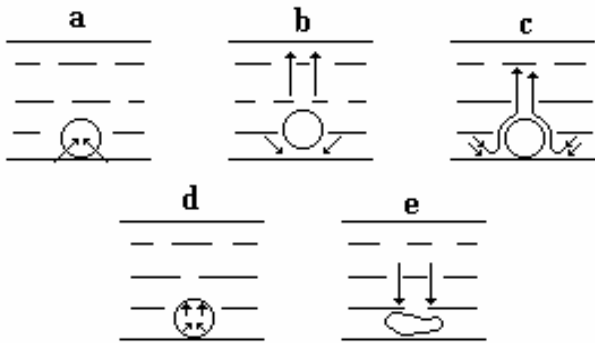

Figure 1. Schemes of different cooling mechanisms

Cooling mechanisms operating through pushing the liquid by growing bubble, through displacement of overheated liquid boundary layer (transient conduction dominated model) or through drift liquid current subsequent to detached bubble (sometimes thought to be separate mechanisms) can presumably be regarded as being separate stages of action of bubbling mechanism.

Subcooling of liquid phase puts in operation two additional cooling mechanisms: evaporation-condensation [5] (Figure 1,d), being an extra version of the micro-layer evaporation mechanism, and quasi-cavitation [6] (Figure 1,e), associated with the collapse of a bubble on the wall under the influence of subcooled liquid. It also belongs to number of convection mechanisms micro-membrane pumping effect (this poorly known dynamical effect of nongravity nature is discussed below).

Micro-layer evaporation

Discovery of local pulsation of boiling surface temperature synchronous with a bubble formation and departure cycle [1] has led to qualitative deepening of understanding of boiling phenomenon.

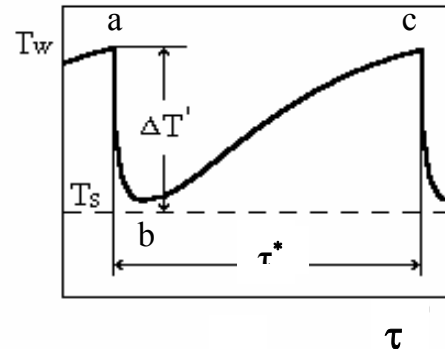

Figure 2. Typical cycle of local temperature pulsation on heating surface [1]

Fundamental outcome of this and further studies of local temperature pulsations is establishment of coincidence of main cooling effect with onset of bubble growth on heating surface (Figure 2., points a and c). It is important also establishment of short-run character of intensive cooling effect (duration of intensive cooling is much less than duration of the cycle itself).

At the same time, in the same and in a number of further studies, exclusive role is attributed to microlayer evaporation in fixed cooling effect based only on the observed synchronism of temperature drop and the onset of a bubble growth. Besides, no evaluations are made of the capability of microlayer evaporation to absorb heat released by heating surface during temperature drop.

In contrast to it, questionably leading role of microlayer evaporation even in cooling of underlying local zone of heating surface is shown in an analysis [4]. Significant excess of heat removed from the boiling surface over the quantity that might be absorbed by the bubble of departure size is also revealed in experiments [7-9]. Fundamental evidences [2,10-14] of dominant role of liquid phase convection in boiling heat transfer remains in force regarding to local temperature pulsations as well.

Contradiction between arising of main cooling effect at the onset of bubble growth and deficient capacity of microlayer evaporation to absorb released heat was resolved in [4] through prediction of strong, so-called, pumping effect of growing bubble (PEGB) (jet-like mechanism) also triggered by the onset of bubble growth. This mechanism will be discussed in detail below.

It also is noteworthy that high intensity of heat transfer in the zone of evaporating microlayer may not explain high intensity of boiling heat transfer: the share of heating surface simultaneously covered by the microlayers is insignificant.

It also deserves significant interest main peculiarities of heat transfer to evaporating liquid microlayers connected just with

low share of heating surface with intensive cooling established in a study [15].

The subject of the analysis [15] is evaporation of a liquid wetting the system of open triangular capillary grooves. The process really represents the case of heat transfer with prevailing role of continuous evaporation of liquid microlayers.

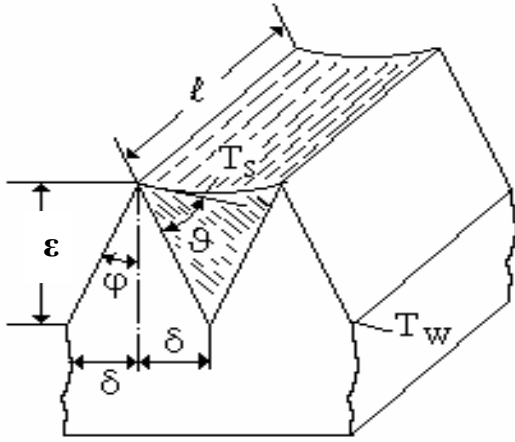

Figure 3. Model of evaporation on triangular groove

The model of the process is presented in Figure 3. The problem, by its essence, relates to the sphere of conjugate heat transfer problems. Correspondingly, taking in account crucial role of concentration of heat flux in the zones of the edges of liquid menisci (to say, in the zones of liquid microlayers) and significant variability of the groove surface temperature, the cross section along bottom points of the capillary grooves is accepted as a basic isothermal surface for determination of HTC [15] (and, further, for its measurement as well [16]).

Corresponding analysis of steady-state heat conduction through combined metal-liquid layer leads to following equation for average HTC during evaporation from triangular capillary grooves:

$$h = \frac{1}{\varepsilon} \sqrt{\frac{\lambda_w \lambda}{\sin \mathcal{A} \operatorname{tg} \varphi}}, \quad (1)$$

where geometrical parameters correspond to Figure 3.

Comparison of equation (1) with experimental data [16] on evaporation of distilled water and steam condensation is presented in Figure 4 (simultaneous presentation of data on evaporation and condensation allows establishing the range of heat fluxes with evaporation without nucleation inside grooves).

As it follows from comparison, in full accordance with equation (1), capability of heating surface to redistribute heat in transverse direction concentrating heat flux in the zones of liquid microlayers strongly influences average HTC (with a factor around 5 between stainless steel and cooper). Besides,

here is presented only the part of wide experimental data [16] confirming equation (1).

In such a manner HTC strongly depends on thermal parameters and thickness of heating surface in any heat transfer process with prevailing role of evaporation of liquid microlayers covering small part of the heating area.

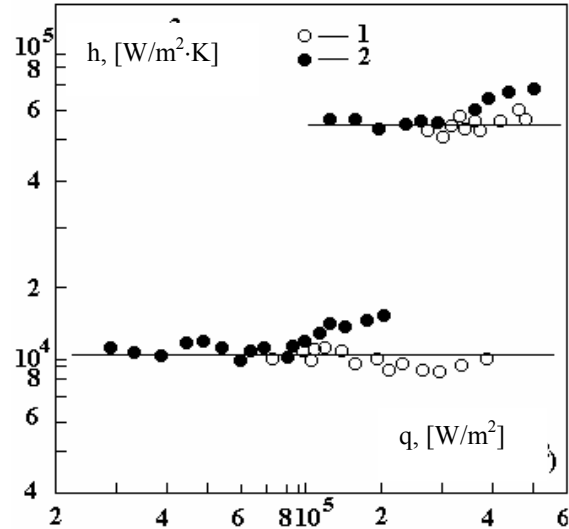

Figure 4. Comparison of equation (1) (horizontal lines) with experimental data [16] on steam condensation and distilled water evaporation on surfaces with triangular grooves ($\varepsilon = 0.5$ mm) made of stainless steel (lower data) and cooper (upper data): 1 – condensation; 2 – evaporation

Correspondingly, the fact, that such an influence of heating surface is not observed in majority of experiments on developed boiling heat transfer, should be considered as evidence of insignificant role of liquid microlayer evaporation in average heat transfer. Below this important aspect of developed boiling heat transfer problem is discussed in more detail.

At the same time aforementioned circumstances do not prohibit microlayer evaporation from the role of tangible cooling mechanism. Its contribution in integral heat transfer is higher at greater shares of contact area of bubbles with heating surface and at comparatively low superheating. In this context, microlayer evaporation may play significant and even leading role in boiling heat transfer at microgravity, at high saturation pressures, on heating surfaces with high-sized nucleation sites and, especially, at transition to prolonged action of the mechanism, for instance, in microchannels.

Bubbling mechanism

Bubbling mechanism is associated with exchange and displacement of liquid and vapour volumes during growth, departure and elevation of vapour bubbles. Bubbling generates complex flow including the stages of pushing the liquid by growing bubble, replacement of detaching bubbles by liquid, displacement of overheated liquid boundary layer by detached

bubble, drift liquid current subsequent to detached bubble (Figure 5). Traditionally this mechanism claimed to be major among boiling heat transfer mechanism.

At the same time presented in Figure 1 typical cycle of local temperature variation [1,7-9] unambiguously shows that only launched by bubble growth mechanism plays leading role in boiling heat transfer. In this connection, assuming that main cooling effect of bubbling takes place consequent to a bubble departure, in [4,17] a conclusion is made about major role of PEGB and second-rate intensity of the bubbling mechanism.

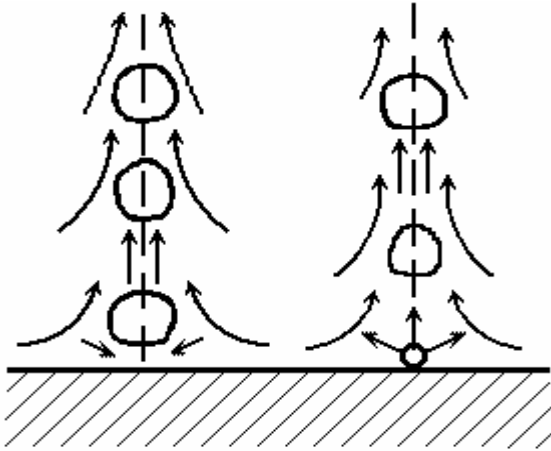

Figure 5. A scheme of bubbling mechanism

This conclusion is confirmed in full measure by experiments [18-19].

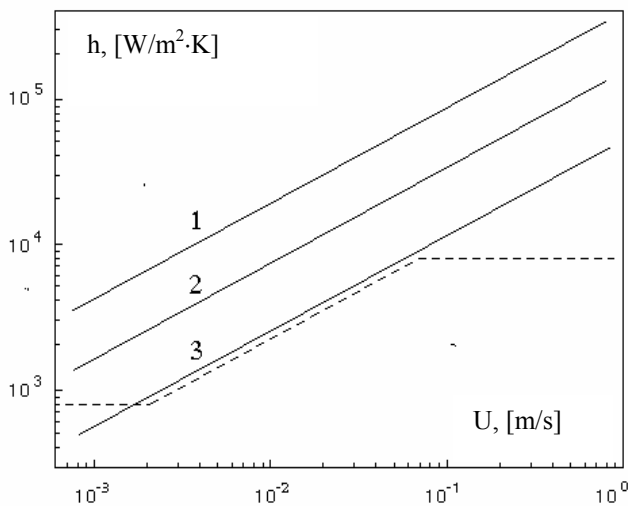

Figure 6. Comparison of experimental data on HTC during boiling of water and during bubbling of humid nitrogen into water through perforated heating surface [19]:
 1 - $h = 3.14 \cdot q^{0.7}$, $q_r/q=0.05$; 2 $h = 3.14 \cdot q^{0.7}$, $q_r/q=0.2$;
 3 - $h = 3.14 \cdot q^{0.7}$, $q_r/q=1$; dotted curve – heat transfer during bubbling

In [18] bubbling mechanism is studied in pure form through bubbling of saturated by hexane inert air through liquid hexane

with simultaneous registration of local heat transfer during the cycle of air bubble growth, detachment and elevation (without evaporation of liquid phase). The most important outcome of the experiment is establishment of maximum intensity of heat transfer consequent to detachment of the bubble. The stages of bubble growth on the heating surface and elevation through liquid are characterized by low intensity of heat transfer.

Insignificance of the role of bubbling mechanism in boiling heat transfer is established also by systematic experimental study of heat transfer during bubbling of humid nitrogen into water through perforated heating surface at atmospheric pressure [18].

In Figure 6 typical dependence of HTC on heat flux during developed boiling of water at commercial surface at atmospheric pressure ($h = 3.14 \cdot q^{0.7}$, here h is in W/m^2K ; q is in W/m^2) is transformed into dependence of HTC from averaged for all heating surface normal velocity of vapour generated immediately at surface for three different values of q_r/q . The dependence also is presented of HTC during bubbling of humid nitrogen into water through perforated heating surface at atmospheric pressure from average for heating surface normal velocity of nitrogen [19] (humidity of nitrogen is considered as sufficient for reducing of evaporation from a bubble surface to negligible rates).

As during boiling of water at atmospheric pressure typical values of q_r/q are much less 0.2 [2,12-14], developed boiling HTC turns out to be 4-5 times higher than the same parameter in corresponding to similar values bubbling regime. Such a result of comparison unambiguously shows secondary importance of bubbling mechanism.

It is evident also that made in [19] opposing conclusion about major role of bubbling mechanism in boiling heat transfer suffers from internal inconsistency. This conclusion is based at experimental data accepted in the case corresponding to condition $q_r/q=1$ (to say, to condition of a priori negligible role of bubbling mechanism). Further, results accepted in such a case are used as an evidence of prevailing role of bubbling mechanism.

The experiments [18-19] are valuable also in terms of revelation of insignificant role of thermocapillary Marangoni convection in boiling heat transfer. This aspect of the problem is touched below.

Pumping effect of growing bubble

PEGB (Figure 6) [4] is caused by sharp variability, along bubble surface, of transverse momentum transport by evaporation, to say, by sharp variability of a reactive force applied to interface (following from [4] physical models and the results of further development of corresponding line of boiling heat transfer research are reflected in [17,20-37]).

Generated in such a way pressure gradient, as a volume force, covers all liquid boundary layer [38] speeding-up liquid flow along the interface. According [23,27] corresponding acceleration may be at two orders of magnitude above of normal gravity acceleration.

Intensity of PEGB strongly depends on initial superheat of boiling surface (speeded-up flow velocity is proportional to

third power of the superheat). In this connection pumping effect is much more intensive at relatively low pressures, small-sized nucleation sites and high surface tension (for instance, in liquid metals). “Switched on” simultaneously with the onset of bubble growth, liquid flow quickly reduces initial gradient of temperature due to that it arises and “cuts off” itself even if a bubble still remains on the wall.

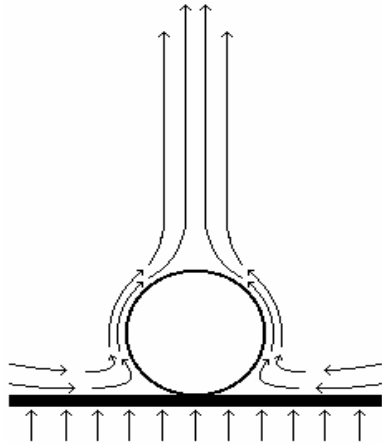

Figure 7. A model of pumping effect of growing bubble

In such a way PEGB reconciles character of local temperature pulsation with prevailing role of heat removal by the liquid phase in majority of boiling processes.

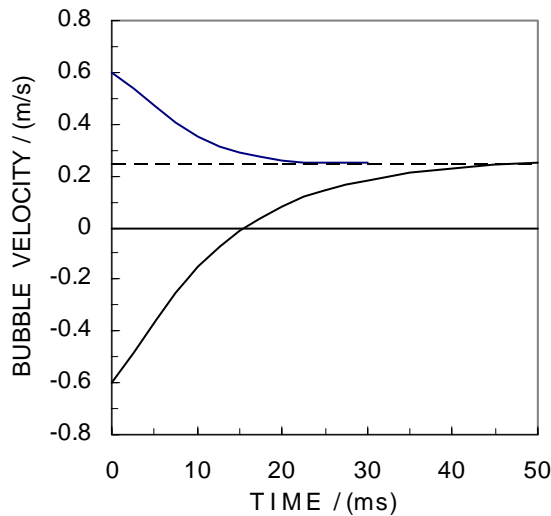

Figure 8. Vertical velocity of vapour bubble subsequent to departure from thin wire [39]: upper curve - upward departure; bottom curve - downward departure; dotted line - equilibrium elevation velocity; point 0 - departure instant

Decisive role could have been played by thorough interpretation of the results of experiments [8,39-40] in establishment of basic role of PEGB in boiling heat transfer.

Discovery of the phenomenon of bubble departure against gravity force (Figure 8) [39] unambiguously evidences high

intensity of PEGB. Roughly constant velocity of bubble departure is registered during boiling of water under atmospheric pressure on thin horizontal wire (\varnothing 0.2 mm) no matter the departure is oriented. Besides, departure velocity (~ 0.6 m/s) is more than twice higher of equilibrium elevation velocity.

As it is noted in [30-31], in context of the mechanism of PEGB, low heat capacity of thin wire and its comparatively insignificant hydraulic resistance to transverse flow create possibility of fast transition of the bubble from the role of the accelerator of the liquid jet to the role of the object to be swept out by the same jet continuing by inertia.

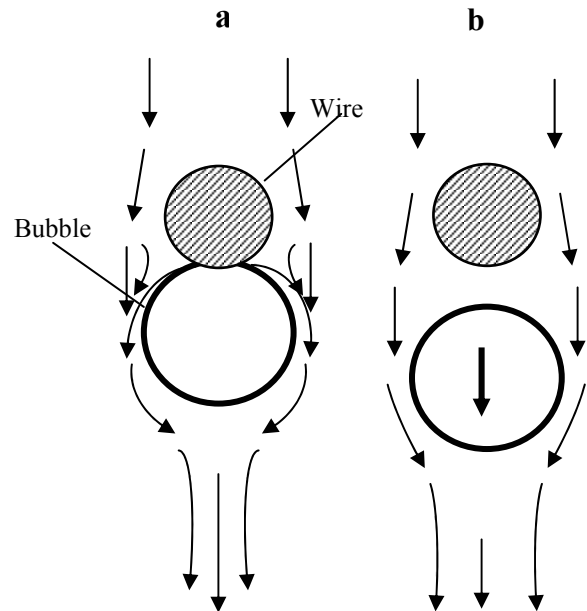

Figure 9. A scheme of bubble departure from thin wire against gravity force

As it is shown in Figure 9, at the stage (a) growing bubble speeds-up jet flow directed transversely to thin wire.

In connection with low heat capacity of thin wire speeded-up liquid flow rapidly eliminates superheat serving as energy source for PEGB. Accordingly, the bubble stops pumping liquid when it still has very small diameter.

Further liquid flow continues by inertia and sweeps the bubble from the wire (the stage b).

Significant role is played here by very small value of gravity force applied to the bubble. As this force is proportional to third order of bubble diameter, small departure size of the bubble makes gravity force extremely weak allowing to nongravity dynamical force to win this concrete opposition.

At the same time, as liquid flow velocity markedly reduces to the stage (b), bubble departure against gravity force with velocity 0.6 m/s evidences speeding-up of much more strong flow at the stage (a).

Although in [39] the single possible general interpretation of the effect is offered (bubble departure by dynamical effect connected with bubble growth itself), the authors desist from

identification of observed character of bubble departure as an evidence of speed-up of strong liquid jet flow at initial stage of bubble growth. Unfortunately, the authors have not fixed foregoing bubble departure liquid jet flows (later clearly observed in just the same conditions [41]).

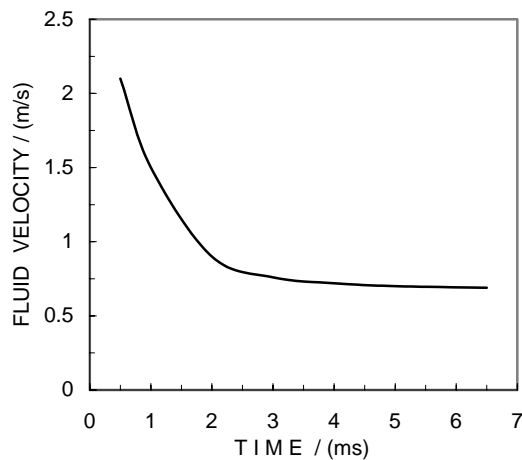

Figure 10. Vertical velocity of superheated liquid from the top of growing bubble [40]

In fact high intensity of PEGB directly is fixed in experiments [40] on boiling of water at atmospheric pressure (to say, during classical boiling process). At that the removal velocity from the top of growing bubble is higher than 2 m/s (Figure 10). Unfortunately, most likely in connection with accidental arithmetic errors, these important data are interpreted as temperature wave propagation through stationary fluid by thermal conductivity (registered velocities are at two-three orders of magnitude higher than possible velocities of such propagation).

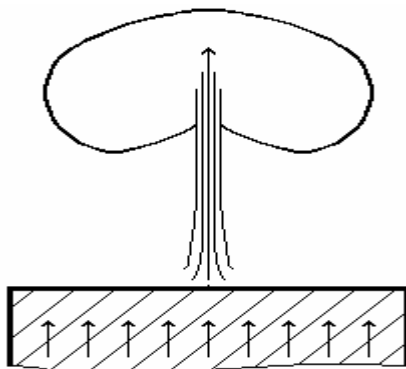

Figure 11. Speeded-up liquid jet flow (5 m/s) penetrating through full-grown large preceding vapour bubble [8]

Comprehensive evidences of insignificance of the role of microlayer evaporation in local temperature pulsations and extremely high intensity of PEGB are presented in [8]. According to this experiment temperature pulsations of massive

(\varnothing 60 mm) cooper substrate penetrate to a depth more than 30 mm. In addition, liquid jets speeded-up by growing bubbles up to velocity 5 m/s are picked up on the film.

As it follows from simple calculations, the heat released from the substrate turned out to be at around two orders of magnitude above that expended for forming a bubble of departure size. Unfortunately, the authors lose an opportunity to demonstrate insignificance of the role of microlayer evaporation in such a simple way.

The authors desist also from any comments regarding linkage of observed extremely strong jet flows (Figure 11) to PEGB. Besides, leaving aside similar strong factual evidences of dominant role of PEGB, the authors attempt to link received experimental data to leading role of microlayer evaporation.

Real steps toward deep and systematic study of PEGB during boiling on thin wires firstly are made in works [41-43,32].

Various rather powerful manifestations of PEGB are observed and recorded, including phenomenon of vapour bubble departure against gravity field. Experimental investigations are performed of diverse dynamical effects including bubble specific motion on microwires. Nongravity character of the observed phenomena is confirmed. Numerical model of bubble motion and adjacent jet flows through subcooled boiling on microwires is developed.

It presents particular interest discovery of so-called multi-jet flow [41-43,] (in addition to single jet-flow) that calls for undertaking of certain refinement of the previous scheme of PEGB (Figure 7).

As it follows from additional analysis tree stages of realization of PEGB may be considered.

At the first stage, during initial bubble growth, an angle between heating wall and bubble surface is sufficiently large for development of two-dimensional liquid flow near the edge bubble-wall. At this stage high initial temperature gradient (and corresponding pressure gradient) is effective on all surface of the bubble and individual jet flow is speeded-up from the top, in full accordance to the previous scheme (Figure 7).

Further, with reducing of the angle, liquid flow in bottom zone evolves to three-dimensional scheme with altering inflows and outflows of liquid. At this stage pressure gradient, still remaining effective at all bubble surface (including upper part of a bubble), provides merger of separate initial outflows into single jet flow.

At the third stage reduction of pressure gradient at upper part of a bubble hinders merger of separate flows and effect of multi-jet flow occurs. Besides, excursion of separate jet-flows from axis of symmetry of a bubble increases with reduction of liquid superheating in upper zone of a bubble.

It should be noted also that, depending on initial temperature distribution (for instance, depending on degree of subcooling) and duration of bubble growth, real development of PEGB may not include part of the stages mentioned.

The example of multi-jet flow speeded-up by a bubble during boiling of subcooled liquid (so-called butterfly-like structure discovered in [43]) is presented in Figure 12. Two hot liquid jet flows outgo from bottom part of a bubble sliding on microwire.

The phenomenon of multi-jet flow presents interest also in context of evaluation of the role of Marangoni flow [44] in observed dynamical effects

As distinct to PEGB, Marangoni flow is driven by surface force generated by gradient of surface tension on interface with variable temperature. However, in the case of single jet flow in symmetric bubble-surface system both of flow schemes are roughly similar.

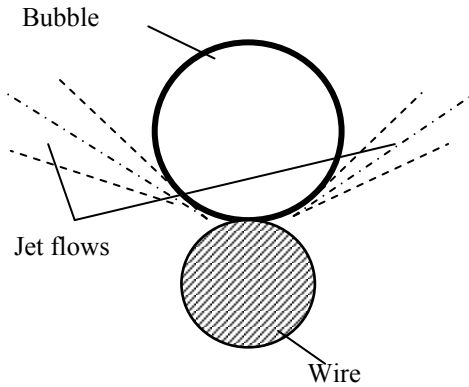

Figure 12. Multi-jet flow during boiling of subcooled liquid on microwire [43]

During boiling of saturated water directly measured and indirectly evaluated jet flow velocities vary in the range 1-5 m/s [8,39-40].

According review of experimental data [45] maximum velocities of steady-state (needing minimum driving force) Marangoni flow are at around 2 orders of magnitude less of aforementioned values. Taking in account that during saturated boiling temperature gradients on bubble surface are near to zero, the conclusion should be made that observed jet flows turn out to be extremely strong to be explained by Marangoni effect. The same conclusion follows from analysis [23,27] showing much greater role of the pressure gradient caused by momentum transport by evaporation in comparison with thermocapillarity. Thereby real contribution of this flow in saturated boiling effects is out of the question.

During boiling of subcooled liquid jet flows are much weaker (characteristic velocities 15-150 mm/s) [42]. Velocities of bubble slippage are in the range 15-40 mm/s [42]. At such a low velocities contribution of Marangoni effect evidently may be tangible. Nevertheless, interpretation of dynamical effects [42-43] by the steady-state thermocapillary Marangoni flow model [46] should be subjected to careful approach.

There are two potential sources of overestimation of Marangoni flow velocities by the model [46]: using of very small value of accommodation coefficient (0.03) and consideration of steady-state flow.

According [47] accommodation coefficient is near to unity on liquid-liquid interface. However, as it is indicated in [46], phase conversion may be affected by presence of noncondensable air. Nevertheless, absence of concrete substantiation of accepted value makes its accuracy questionable. The more so as no consideration is made of the

concentration of noncondensables on the condensation side of the bubble interface (this circumstance evidently results overestimation of intensity of Marangoni convection along evaporation zone of the bubble). The last conclusion especially concerns presented in Figure 12 butterfly-like structure that just is developed along the zone of evaporation.

During boiling, clearly defined zone of maximum surface tension on the top of the bubble calls into principal question possibility of speeding-up by Marangoni effect of multi-jet flow. In this context, occurrence of multi-jet flow always can be considered as evidence of prevailing role of PEGB.

Concerning intensities of different cooling mechanisms (including Marangoni flow) important conclusions could have been done also based at aforementioned experiments on heat transfer during bubbling [18-19].

As bubbling of humid air is not connected with tangible evaporation of liquid phase, temperature drop on bubble surface before departure practically is equal to temperature drop between heating surface and bulk liquid.

In contrast to it, during boiling, temperature at bubble surface practically is equal to saturation temperature corresponding to the pressure in bubble itself. Only some superheating of bubble surface takes place in the zone of microlayer adjacent to heating surface. Corresponding variation of temperature along the surface of vapour bubble is small and may achieve maximum several percent of temperature drop between boiling surface and saturated bulk water.

In this connection, if during bubbling variation of bubble surface temperature may be of order 10 K, during boiling at the same heat flux such a variation may achieve 0.1 - 0.2 K only.

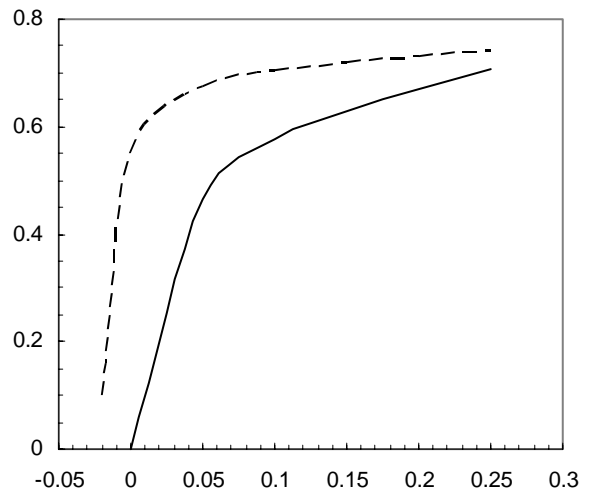

Figure13. Experimental data on CHF during pool boiling of water, nitrogen and hydrogen under reduced gravity acceleration – dashed line [49]; Solid curve – according hydrodynamic theory of Kutateladze [48]

In such a manner, during bubbling thermocapillary driving force is at around two orders of magnitude stronger in comparison with comparable boiling process. In this connection fixed low intensity of heat transfer during air bubble growth

[18] and low average HTC [19] unambiguously demonstrate insignificance of Marangoni convection in boiling heat transfer.

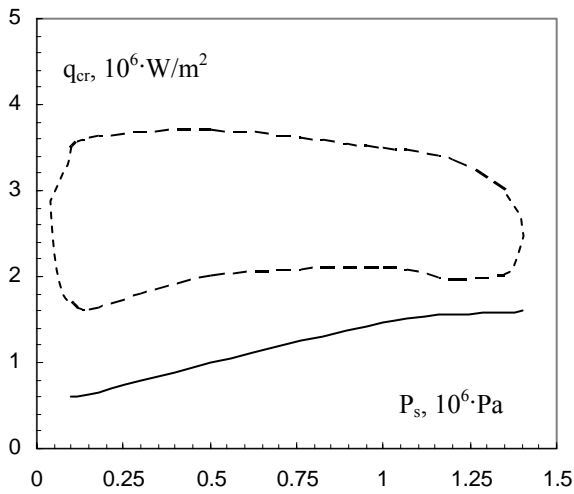

Figure 14. Experimental data [52] on CHF during pool boiling of sodium (outlined by upper loop); bottom curve - according hydrodynamic theory of Kutateladze [48]

It also presents significant interest potential role of PEGB in forced convection boiling in microchannels and pulsating heat pipes. This important aspect of the problem is discussed below.

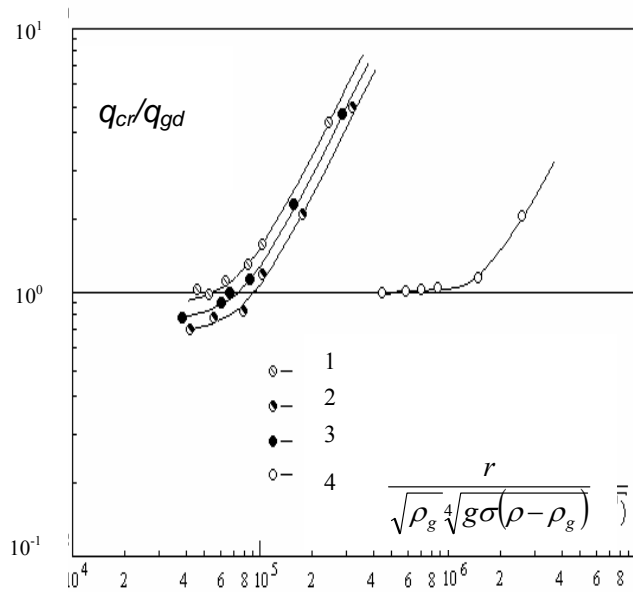

Figure 15. Experimental data [28] on CHF during pool boiling of dautherm-A (1), chlorbenzene (2), toluene (3), and water (4) at reduced saturation pressures; horizontal line - according hydrodynamic theory of Kutateladze [48]

Finalizing the subchapter let us discuss briefly potential influence of PEGB on critical heat flux (CHF).

As it is known, critical heat flux (CHF) depends on intensity of mechanisms responsible for vapour phase removal from heating surface. Hydrodynamic theory of boiling crisis of Kutateladze [48], assuming basic role of gravity field in vapour

phase removal, quite adequately describes experimental data on CHF during pool boiling of ordinary liquids. At the same time, there is some part of pool boiling processes characterized by significantly higher values of CHF in comparison with predicted by the hydrodynamic theory.

In particular, such a lead is established during boiling of water, nitrogen, hydrogen, *n*-pentane, CFC and other liquids in microgravity [49-51] (Figure 13), during pool boiling of liquid metals [52] (Figure 14), during pool boiling of organic liquids and water under vacuum [28] (Figure 15).

According to presented comparison excess of experimental data on HTC over theoretical values achieves 300-500%. Such a result can be considered as an evidence of existence of certain rather strong nongravity mechanism of vapour phase removal from heating surface. As aforementioned boiling conditions (microgravity, low saturation pressures) just are favourable for PEGB, it is supposed [30-31] that just PEGB is responsible for high values of CHF. However, this aspect of boiling problem needs further detailed investigation.

Micro-membrane pumping effect

It also presents certain interest specific convective heat transfer mechanism by liquid phase [27] linked to permanent vibration of nucleus surfaces in all potential sites, synchronously with local pulsation of boiling surface temperature. Such a cooling mechanism may be named as micro-membrane pumping effect (MMP).

While local temperature increases, nucleus surface (a micro-membrane) expands to critical profile, stops expansion when the nearest nuclei launches growth of a bubble with corresponding cooling effect and returns to previous position when local temperature drops. Besides, in connection with quick drop of local temperature, contraction of the micro-membrane takes much less time than its expansion. Correspondingly, downward motion of the micro-membrane is much faster. The last circumstance, together with almost ideal distribution of such downward flows on heating surface (on huge number of potential sites (up to 10^3 cm^2)), presents important feature of MMP.

In such a manner, similar to PEGB, MMP presents dynamical effect of nongravity nature main cooling action of which also is triggered by onset of bubble growth.

Velocity of downward motion of the micro-membrane depends on effective radius of nucleation site and on the scale and time of local temperature drop. According preliminary evaluations, in characteristic regimes of boiling heat transfer, such a velocity may vary in rather wide range from 0.5 mm/s to 20 mm/s. In contrast to PEGB, cooling effect of MMP may not claim to be dominant. However, the effect deserves to be studied analytically and experimentally.

A slope of boiling heat transfer curve

A slope of boiling heat transfer curve in coordinates $q \sim h$ or $\Delta T \sim q$ (determined by an exponent in equations of the type $h \sim q^n$ or $q \sim \Delta T^m$) varies in rather wide range ($n=0.5-0.9$). In the main part of experiments on developed boiling performed on

commercial surfaces the slope varies in comparatively narrow limits ($n=0.65-0.75$).

The problem of the slope of boiling curve in certain degree is clarified by experimental data [21] on boiling of benzene at atmospheric pressure on heating surfaces with different densities of artificially created big uniform nucleation sites (much greater of natural sites of the same surface) (Figure 16).

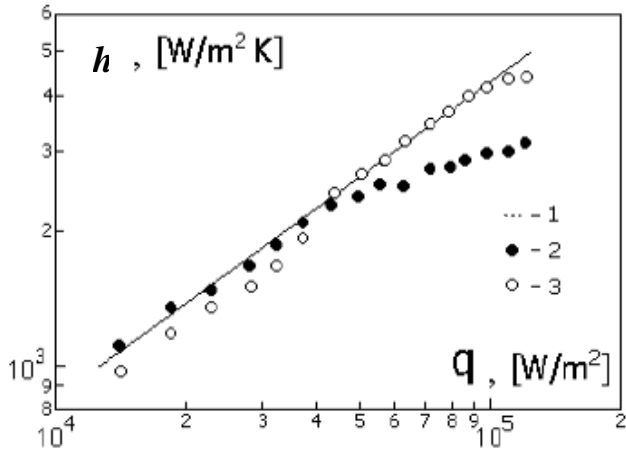

Figure 16. Heat transfer during developed boiling of benzene at atmospheric pressure on heating surfaces with different densities of uniform nucleation sites [21]: 1 - $N/A=4 \cdot 10^6 \text{ m}^{-2}$; 2 - $N/A=1 \cdot 10^6 \text{ m}^{-2}$; 3 - $N/A=0.25 \cdot 10^6 \text{ m}^{-2}$

As it follows from experimental data, at sufficient density of nucleation sites, all boiling curves equally correspond to developed boiling curve with typical slope $h \sim q^{0.7}$ (covered in full range by the surface with $N/A=4 \cdot 10^6 \text{ m}^{-2}$). In this case increase of heat flux evidently leads only to "switching on" of additional artificial sites with the same effective radii.

At the same time, if all artificial sites of given surface already are "switched on", further increase of heat flux may additionally put in operation only natural sites of the basic surface. On the other hand, as activation of natural sites requires significantly higher superheating, it may be supposed that increase of heat flux is accompanied by tangible deviation of boiling heat transfer curve from the previous slope.

Presented data unambiguously reflect dependence of the slope of boiling heat transfer curve on density and sizes of nucleation sites. In certain approximation, typical for majority of experiments slope turns out to be linked to heating surface with great number of nucleation sites with roughly uniform effective radius*.

Presented conclusions are supported by important experimental data [53] on sizes and distribution of operating

* As it was established later, used in [21] procedure of determination of effective radius of conical artificial sites has led to significant (roughly fourfold) overestimation of this parameter. However, this disadvantage had no influence on uniformity of artificial sites of experimental surfaces. Correspondingly, it also remains in force the conclusion made based at uniformity of artificial nucleation sites.

natural nucleation sites studied through immediate optical observation during boiling on heating surfaces with different finish classes (with standard roughness parameter R_p from 0.1 to 0.4 μm).

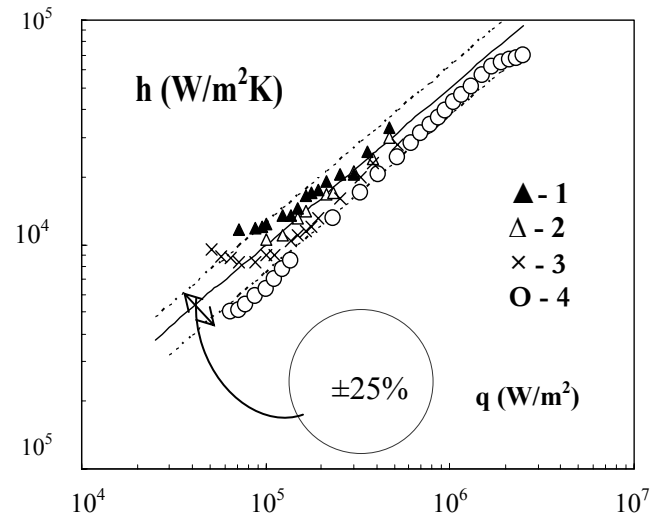

Figure 17. Heat transfer during developed boiling of water at atmospheric pressure on heating surfaces with different finish classes [53] (1 - $R_p=0.4 \mu\text{m}$; 2 - $R_p=0.125 \mu\text{m}$; 3 - $R_p=0.1 \mu\text{m}$) and on thin platinum wire [54] (4)

As it follows from Figure 17, despite fourfold variation of standard roughness parameter, experimental data correspond to known empirical equation for boiling heat transfer of water on commercial surfaces at atmospheric pressure ($h = 3.14 \cdot q^{0.7}$) within usual accuracy of boiling HTC measurement.

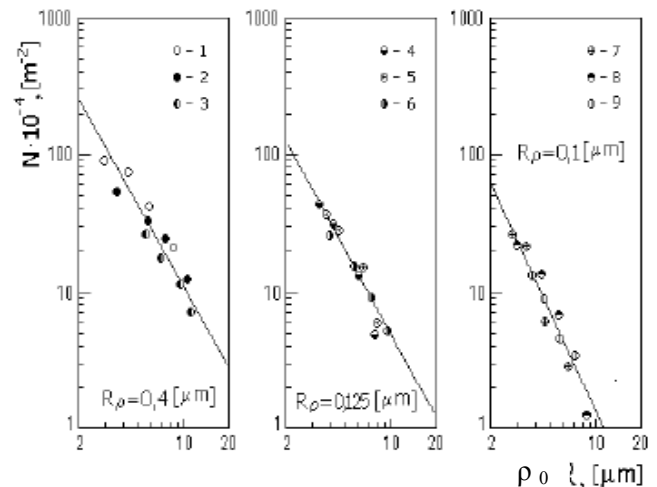

Figure 18. Distribution of radii of nucleation sites at different heat fluxes on surfaces with different finish classes [53]:

- 1 - $q=1.67 \cdot 10^5 \text{ Wm}^{-2}$; 2 - $q=1.2 \cdot 10^5 \text{ Wm}^{-2}$;
- 3 - $q=0.89 \cdot 10^5 \text{ Wm}^{-2}$; 4 - $q=1.2 \cdot 10^5 \text{ Wm}^{-2}$;
- 5 - $q=1.13 \cdot 10^5 \text{ Wm}^{-2}$; 6 - $q=0.93 \cdot 10^5 \text{ Wm}^{-2}$;
- 7 - $q=1.31 \cdot 10^5 \text{ Wm}^{-2}$; 8 - $q=1.14 \cdot 10^5 \text{ Wm}^{-2}$;
- 9 - $q=0.92 \cdot 10^5 \text{ Wm}^{-2}$

Distribution of effective sizes of operating nucleation sites (Figure 18) also shows insignificant stratification with surface finish classes. Besides, nucleation sites are almost at two orders of magnitude bigger than standard roughness parameter.

Fixed radii of nucleation sites vary within rather narrow limits from 3 to 10 μm (with comparatively great share of small sites) revealing absence of any linkage to standard roughness parameter. In rough approximation the value 5 μm can be accepted as average radius of nucleation sites.

It should be stressed also that practical independence of HTC on standard roughness parameter during its fourfold variation demonstrates principal problems with using of similar parameters for evaluation of the role of heating surface in boiling heat transfer. In this context the results [53] fully confirm the model [4,17] unambiguously linking HTC to average effective radius of nucleation sites. This important aspect of the problem is discussed in detail below.

At the same time coincidence of experimental data on HTC [53] with known data on developed boiling of water on commercial surfaces at atmospheric pressure supports the previous assumption [17] about rough equality of average effective radius of nucleation sites of commercial surfaces to 5 μm .

Below we return to discussion of the data [53] in regard to boiling on thin platinum wire ($\varnothing 0.3 \text{ mm}$) [54] also presented in the same Figure 17.

Two basic features of developed boiling heat transfer

Wide diversity of cooling mechanisms significantly complicates creation of qualitative physical model of developed boiling heat transfer simplifying the phenomenon in adequate way. In this context it gains crucial importance identification of the most important fundamental features of the process shaping its regularities.

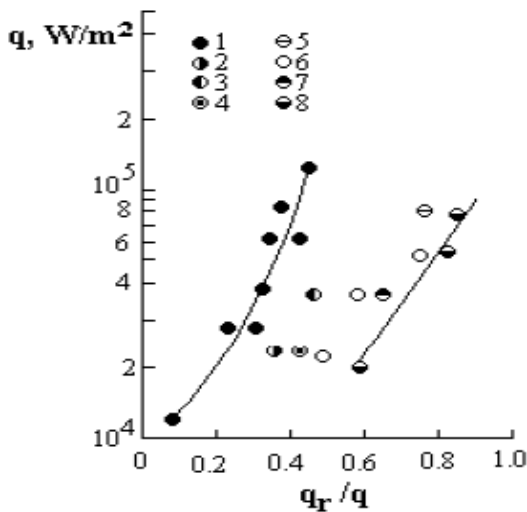

Figure 19. Contributions of evaporation and liquid phase convection mechanisms with variation of acceleration of body force [55]: g/g_0 : 1- 1; 2 - 0.3; 3 - 0.25; 4 - 0.2; 5 - 0.14; 6 - 0.1; 7 - 0.057; 8 - 0.03-0.04

According our analysis the most important basic features of developed boiling heat transfer are the following:

- Independence of superheat of heating surface on intensities of separate cooling mechanisms;
- Simultaneous triggering by the onset of a vapor bubble growth of the main cooling mechanisms (by liquid phase convection and microlayer evaporation).

Experimental fundamentals of such a conclusion are discussed below.

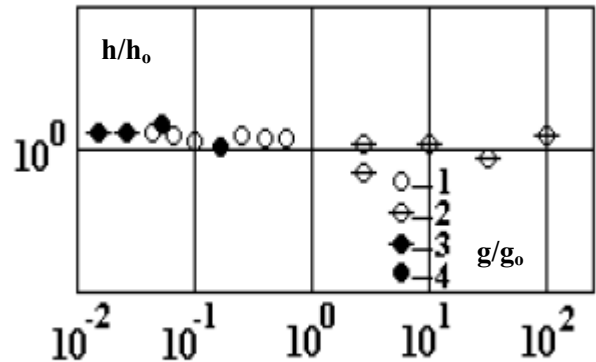

Figure 20. Boiling HTC under different intensities of gravity force normalized to normal gravity condition [55]: 1 – oxygen; 2 – water; 3 – ethanol; 4 – ethyl ether

In Figure 20 experimental data [55] are presented reflecting qualitative redistribution of the shares of immediate evaporation and convection (by liquid phase) cooling mechanisms with variation of intensity of body force. In particular, evaporation mechanism, playing secondary role at normal gravity, gains leading role with reduction of g around 20 times.

In contrast to it, experimental data [56] presented in Figure 20 reflect independence of HTC from variation of intensity of body force at around four orders of magnitude. Similar results are received also in [57-59] carried out in the range of variation of mass acceleration from $10^{-6}g_0$ to $5 \cdot 10^3g_0$ (almost 10 orders of magnitude).

Experimental data [59] presented in Figure 21 reflect independence of HTC during boiling of CF-72 on small heaters on variation of acceleration of body force in the range $(0.02 - 1.8)g_0$ and on variation of subcooling of bulk liquid in the range 7-34 K.

Presented in Figure 22 heat transfer curves reflect regularities of forced convection boiling on horizontal tube in the conditions of crossflow of slightly subcooled R113 [60]. Forced convection heat transfer curve always comes together with developed pool boiling curve with the climb of heat flux. At that crossflow velocity (0.03 – 0.235 m/s) and the degree of subcooling (6 K) influence only on parameters of merger of the forced convection boiling curve with the developed boiling curve.

The same conclusions are made in generalized description of forced convection boiling in [61].

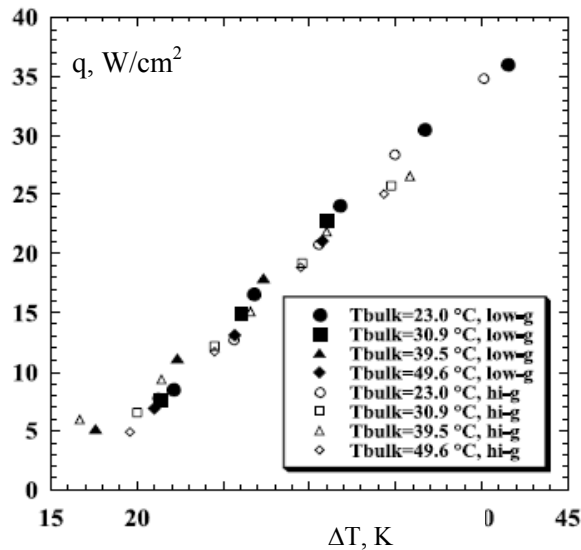

Figure 21. Pool boiling of CF-72 on small heaters under subcooling and different gravity accelerations [59]

Experimental data on influence of orientation of heating surface in gravity field on boiling heat transfer of water at atmospheric pressure are presented in Figure 23 [62]. As it follows from presented data developed boiling mode is conservative regarding to this type of influence as well. Similar results are received also in detailed study [63] (in this work, corresponding figures are plotted using HTC determined through full temperature drop between boiling surface and subcooled liquid).

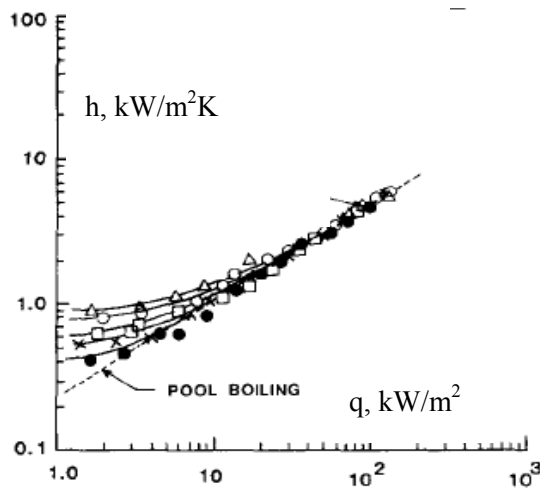

Figure 22. Forced crossflow boiling on horizontal tube of slightly subcooled R113 [60]: upper curves correspond to higher crossflow velocities

The same conservatism of developed boiling heat transfer law manifests itself in the part of experiments on flow boiling in minichannels and microchannels although the results of some experiments show qualitatively differing trends. This aspect of the problem will be touched below [64-68].

In this context it also presents significant interest comparative consideration of the experimental data on boiling of water on massive heating surface made from cooper [53] and on thin platinum wire with diameter 0.3 mm [54] at atmospheric pressure (Figure 17).

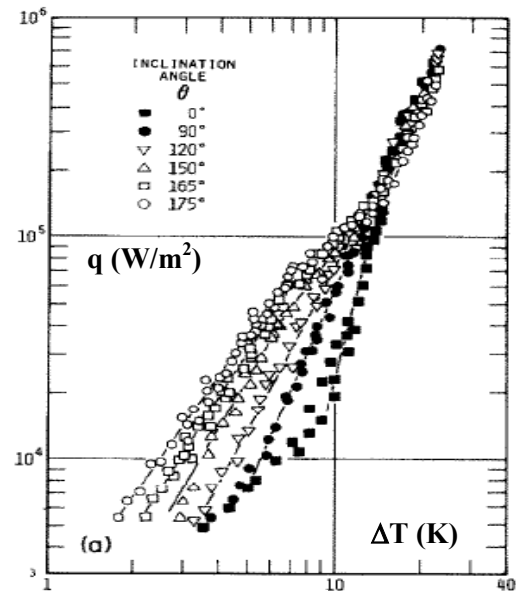

Figure 23. Influence of inclination of heating surface on boiling heat transfer of water at atmospheric pressure [62]

Discussed above peculiarities of boiling on thin wires allow to conclude that these two processes are characterized by qualitatively differing interphase hydrodynamics. If in the case of massive horizontal cooper surface gravity force is main driver of two-phase flow, in the case of thin wire leading role in vapour removal from heating surface is gained by nongravity dynamical effects. Despite such a drastic dissimilarity of these two boiling regimes, unified developed heat transfer law equally remains in force in the both cases.

In such a manner, changes in the pattern of mutual motion of the liquid and vapor phases, in the numbers of operating nucleation sites and in the bubble departure diameters and frequencies, occurring with a change in the intensity of body force by several orders of magnitude, with change of orientation of heating surface in gravity field, with forced convection and subcooling of bulk liquid, all of these conditions have virtually no influence on heating surface superheat in the mode of developed boiling.

According to our analysis this fundamental fact may be interpreted only assuming existence of certain physical mechanism that controls developed boiling heat transfer through multiple triggering of short-run actions of different heat removal mechanisms and holds certain integral cooling effect irrespective to the rates of these mechanisms.

At the same time the last conclusion simultaneously serves as a key to identification of the next in importance basic feature - simultaneous triggering by the onset of vapor bubble growth of the both liquid phase convection (PEGB) and evaporation

(microlayer evaporation) mechanisms. Although the same onset also triggers another convective cooling mechanism discussed above (MMP), in connection with a lack of detailed information, we shall keep it in store for the time being.

The onset of bubble growth itself is triggered by overcoming by average temperature of the critical-size nucleus meniscus the level corresponding to thermodynamic equilibrium in the nucleus-liquid-site system. Consequently, the process of establishment of corresponding superheat of heating surface just presents the mechanism that controls intensity of developed boiling heat transfer.

MTA AND MTD

Beginning from Jakob [2], Kruzhilin [69] and Rohsenow [70] and further [71-84] main line of development of boiling heat transfer theory is based at approaches connecting HTC to intensity of certain cooling mechanism (an actor) or certain combination of different cooling mechanisms (actors).

In this connection in the lecture these approaches are subsumed under the category dubbed as a model of "the theatre of actors" (MTA). Besides, approaches based at qualitative consideration and dimensional analysis in the light of cooling mechanisms also are prescribed to this category.

Principal restrictions of MTA

MTA presents efficient universally adopted way of analysis in convection heat transfer theory. However, as it follows from above discussion, developed boiling heat transfer manifests qualitative peculiarities resulting exceptionally specific sequence of causes and effects.

In the framework of MTA heating surface temperature is determined by intensity of cooling mechanisms. Really maximum local superheating of heating surface during developed boiling is found to be determined by thermodynamic conditions at transition of a nucleus through critical size at the onset of bubble growth.

In the framework of MTA so-called internal characteristics of boiling (densities of operating sites and bubble departure diameters and frequencies) naturally become main instrument for determining of temperature regime of heating surface. In real situation combination of these parameters also turns out to be controlled by thermodynamic conditions at nucleation sites in correspondence with temperature regime to be hold.

Evident contradiction of MTA with the aforementioned basic feature of developed boiling heat transfer (independence of heating surface superheat on qualitative changes in intensities of separate cooling mechanisms) calls into principal question efficiency of MTA in terms of establishment of boiling heat transfer law.

For evaluation of real efficiency of MTA it is quite sufficient to rely on conclusions made in authoritative reviews [85-87] published during last years.

According to the review [85-86], among numerous MTA-based correlations, two correlations are regarded as more accurate fitting to boiling HTC data (except liquid metals and cryogenic liquids) using different constants and powers for

different surface-liquid combinations. Another review [87] regards as the most comprehensive a correlation [78] dividing liquids into four groups. Besides, liquid metals remain outside of consideration even in the case of such a multiple division.

By the way, reviews [85-87] fail to discuss a correlation [17,26,29-31] describing wide experimental data on developed boiling of all groups of liquids, including liquid metals, without dividing of liquids into groups and without matching different constants and powers to different surface-liquid combinations.

Although given in [85-87] evaluations of advances of MTA quite clearly demonstrate principal character of its restrictions in the context of universal description of developed boiling heat transfer, it presents certain interest discussion of some concrete disadvantages of MTA.

As bubbling and microlayer evaporation directly are linked to buoyancy driven convection in two-phase area, it is hardly achievable in the framework of MTA to get free in correct way from influence of gravity field on HTC. This conclusion especially concerns the models introducing vertically driven two-phase structures as the basis for analysis of boiling heat transfer [70,74-76,78, 81-83].

If HTC is determined by interactions on boundaries and inside such a structures, it is hardly explicable why heating surface superheat during developed boiling remains unchangeable through essential transformation (for instance, through change of gravity acceleration at several orders of magnitude) or even with full disappearance of these structures (for instance, under deep subcooling).

The problem of adequate reflection of the role of gravity field also remains pressing in the case of qualitative dimensional considerations.

For instance, aforementioned correlations for four groups of liquids [68] are developed through regression analysis applied to numerous data points on HTC during boiling of different liquids. The analysis starts from more than 10 dimensionless numbers obtained in the framework of MTA. Finally the following dependences of HTC on gravity acceleration are obtained for separate groups of liquids:

$$h \sim g^{0.483} \text{ (for water)}$$

$$h \sim g^{-0.085} \text{ (for hydrocarbons)}$$

$$h \sim g^{-0.515} \text{ (for cryogenes)}$$

$$h \sim g^{0.033} \text{ (for refrigerants)}$$

Similar qualitatively differing dependences hardly allow to considering approach [68] as linked to physics of studied phenomenon.

Principal disadvantage of microlayer evaporation version of MTA is connected with contradiction between independence of HTC on thermal parameters of heating surface during developed boiling and aforementioned conclusion [15-16] about significant influence of thermal conductivity of heating surface on average HTC in the processes with prevailing role of microlayer evaporation (by the way, this conclusion is

supported by numerical MTA-based models of boiling heat transfer [80,84] developed based at assumption on leading role of micro and macrolayer evaporation mechanisms).

In general, comprehensive approach to boiling heat transfer problem should allow to interpreting independence of HTC on thermal parameters of heating surface during developed boiling and reality of influence of the same parameters in some other regimes. The same conclusion concerns the phenomenon of boiling heat transfer hysteresis that also is observed only in the part of experiments. No MTA-based approach meets these challenges.

Another disadvantage of MTA is connected with principal difficulties with incorporation of characteristic linear size of nucleation sites. In this connection MTA turns to be incapable to make use of wide investigations in the physics of nucleation and concrete peculiarities of operation of nucleation sites.

As average effective size of nucleation sites strongly influences HTC (within an order of magnitude, all other things remain the same), failure to take account of such a crucial factor excludes possibility of adequate description of the process in principle. It should be stressed also that establishment of adequate set of dimensionless numbers without incorporation of the same characteristic size also is impossible in principle.

MTD and MTD-based analysis

Aforementioned main features of developed boiling actually have predetermined alternative approach to the problem assuming certain mechanism controlling developed boiling heat transfer. This mechanism holds given average HTC by multiple triggering of short-run actions of different cooling mechanisms irrespective to variations of the rates of these mechanisms.

At the same time bubble growth onset is identified as a trigger of main cooling mechanisms. The onset itself is triggered by overcoming by average temperature at the nucleus meniscus of critical size of the temperature corresponding to thermodynamic equilibrium in the nucleus-liquid-site system.

Corresponding model of developed boiling heat transfer [4,17,26,29-31,36] is named as a model of “the theatre of director” (MTD).

MTD incorporates one-parameter model of boiling surface comprising unlimited number of identical stable nucleation sites characterized by unchangeable level of superheat triggering growth of the first and following bubbles.

The role of such a site may be played by conical recess satisfying the condition:

$$\frac{1}{2}\beta < \theta < 90^{\circ} \quad (2)$$

In the similar site minimum curvature radius of the nucleus surface (effective radius of nucleation site ρ_0) is equal to the radius of the mouth of the recess [88] (Figure 24). Sufficiently deep cylindrical recess or the recess with narrowed mouth corresponds to this requirement even in the case of zero contact angle.

In this framework ρ_0 (being equal to radius of the mouth for active and potential sites as well) is the only characteristic of one-parameter boiling surface which influences HTC. Then the analysis of heat transfer can be reduced to determining the parameters of the wall temperature time dependence for the zone of action of operating site.

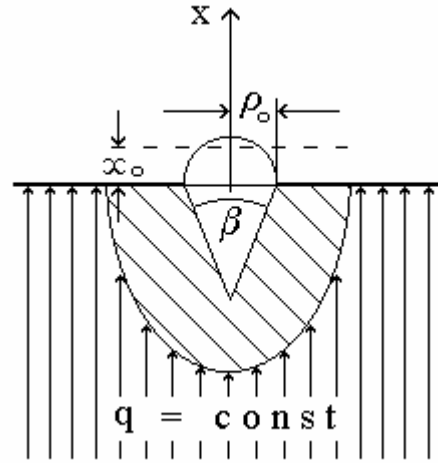

Figure 24. A scheme of the zone of nucleation site

To the first approximation (Figure 25) typical curve of local temperature variation can be approximated by the curve presupposing instantaneous drop in the wall temperature down to the saturation temperature at the time of onset of bubble growth (instantaneous start-up and shut-down of extremely intensive heat removal mechanism) and further warming-up of the wall through heat conduction up to the moment of onset of the next bubble growth.

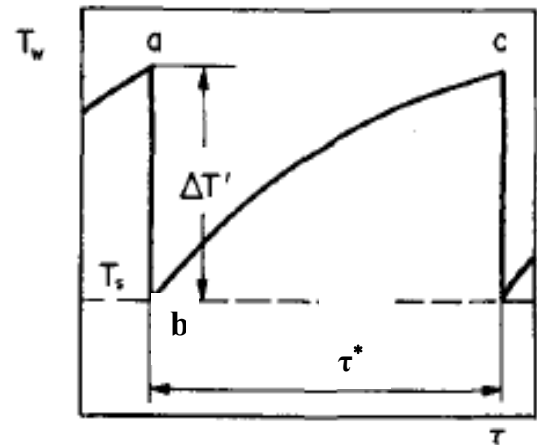

Figure 25. The first approximation

Under boiling conditions critical nucleus is found in the zone of high temperature gradient. The superheat ΔT_0 , necessary for bubble growth onset, should be achieved at the meniscus of the nucleus in average. Concomitant heating surface superheat ΔT^1 is much above ΔT_0 . Corresponding unsteady-state process is considered as warming-up of initially isothermal liquid semi-infinite region (with initial temperature

of liquid equal to T_s) through transient heat conduction at suddenly posed boundary condition $q = \text{Const}$ (nucleus growth in superheated layer is studied also in [89]).

As it is known, the superheat required for bubble nucleation under equilibrium thermodynamic conditions is determined by the relationship [88]:

$$\Delta T_0 = \frac{2\sigma T_s}{r\rho_0\rho_g} \quad (3)$$

General solution of the problem [90] leads to the following equation:

$$T(x, \tau) - T_s = \frac{2q}{\lambda} \sqrt{\alpha\tau} \operatorname{ierfc} \frac{x}{2\sqrt{\alpha\tau}} \quad (4)$$

The mean superheat of heating surface accordingly is equal:

$$\begin{aligned} \Delta T &= \frac{1}{\tau_0} \int_0^{\tau^*} [T(0, \tau) - T_s] d\tau = \\ &= \frac{2}{3\sqrt{\pi}} \frac{q}{k} \sqrt{\alpha\tau^*} \end{aligned} \quad (5)$$

Written out in non-dimensional form this equation is:

$$Nu = \frac{3\sqrt{\pi}}{2} \frac{\rho_0}{2\sqrt{\alpha\tau^*}}, \quad (6)$$

where:

$$Nu = \frac{h\rho_0}{k} \quad (7)$$

The time of climb of heating surface temperature τ^* is the same as the time of attainment by certain section x_0 of the meniscus of nuclei of superheat equal to ΔT_0 . Taking in account $x_0 \sim \rho_0$, the following relationship is acquired:

$$\frac{\rho_0}{2\sqrt{\alpha\tau}} \operatorname{ierfc} \frac{\rho_0}{2\sqrt{\alpha\tau}} = \frac{K}{2}, \quad (8)$$

where:

$$K = \frac{q\rho_0^2 r\rho_g}{\sigma k T_s} \quad (9)$$

The results predicted by equations (6) and (8) are shown in Figure 26 in the coordinates $Nu = f(K)$. Experimental data on

HTC during developed boiling of water [91], nitrogen [92] and sodium [93] at atmospheric pressure on commercial surfaces also are plotted (assuming for commercial surfaces uniform value of average effective radius $\rho_0 \approx 5 \mu\text{m}$).

Analytical prediction of the order of magnitude of HTC for greatly differing liquids may be considered as certain support of validity of qualitative basics of MTD.

Important outcome of the solution is uncovering of the role of effective radius as linear size characteristic for developed boiling heat transfer. It is important also outlining of the role of the number K (the number of similar structure has been obtained in [69] with the bubble departure diameter as characteristic linear size).

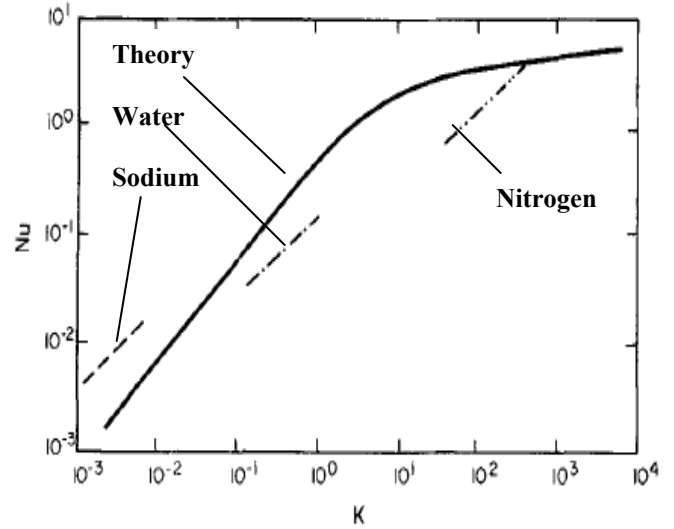

Figure 26. Comparison of equations (6) and (8) with experimental data

Uncovering of the role of ρ_0 stresses incompleteness of overwhelming majority of experimental studies of developed boiling heat transfer. Only exclusive studies have been accompanied by investigation of characteristics of nucleation sites. This important aspect of boiling problem will be touched below.

Further the theory is refined making emphasis on peculiarities of heat transfer on periphery of action zone of operating nucleation site.

Superheat at the periphery of action zone makes major contribution to average superheat of the whole zone and to average superheat of the boiling surface, as a whole.

In the framework of MTD and one-parameter model of boiling surface the area of action zone is determined by capability of firstly activated nucleation site to prevent by own cooling effect activation of adjacent potential sites. If the zone of influence of operating site reduces, additional site or sites with the same ρ_0 turn on operation on the periphery (and vice versa).

In such a manner the “director” holds unchangeable level of superheat of heating surface just at the periphery of action zone. At that the number of operating sites automatically varies meeting this basic condition. The range of variation of the

number may be quite wide, for instance, during significant change of mass acceleration or liquid subcooling at constant saturation pressure and heat flux.

Self-control of the number of operating sites depending on cooling effect of separate sites presents a basis for applying to boiling of the theory of self-organized structures [94]. Thereby experimental "discovery of self-organized and cooperative or competitive phenomena among sites or bubbles in boiling systems" [95] presents direct support of MTD. It also is no surprise that the main pragmatic finding regarding boiling HTC enhancement is creation of great number of large-sized nucleation sites (directly predicted by equations (6) and (8) and by the correlation (16)).

Another important peculiarity is decisive role, in the periphery cooling process, of convective cooling mechanisms always possessing some inertia. Correspondingly, cooling effect may not be shut-down suddenly.

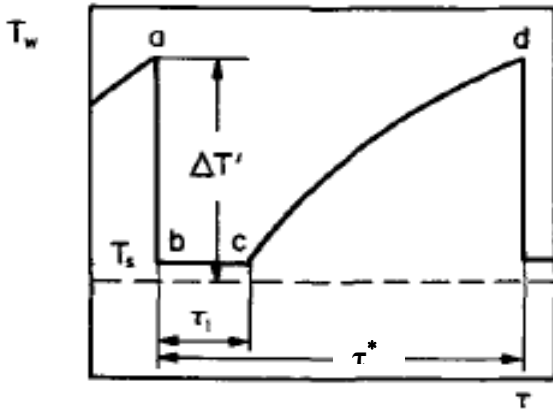

Figure 27. Approximated temperature behaviour in peripheral zone

Behaviour of heating surface temperature in the peripheral zone can be approximated by the curve presented in Figure 27. It is assumed that the period of action of cooling mechanisms can be represented by broken curve abc the equivalence of which to the real pattern of the process can be ensured by suitably selected value of τ_1 . Heating surface superheat in this period is considered to be small and its role in the time-average superheating is neglected. Segment cd characterizes the period of the same warming-up of initially isothermal liquid semi-infinite region. In this case the maximum superheat remains insignificantly less than ΔT^l , and may be approximately equated to it.

Correspondingly, functional relationship for Nusselt number can be widened through introduction of the ratio τ_1/τ_0 :

$$Nu = f(K, \tau_1 / \tau_0) \quad (10)$$

The ratio τ_1/τ_0 is determined by viscous dissipation of the energy of liquid motion continuing by inertia after its inception at the onset of bubble growth. It is, therefore, the function of appropriately specified Reynolds number. Accordingly, equation (10) will acquire the form:

$$Nu = f(K, Re) \quad (11)$$

Further certain evaluations are obtained for characteristic liquid velocity and linear size. Considering a work of expansion as a driver of all dynamical effects, characteristic velocity is evaluated as proportional to square root from the specific work of expansion:

$$U \sim C_1 \sqrt{P(v_g - v)}, \quad (12)$$

where C_1 is much below of unity.

Characteristic for two-phase hydrodynamics linear size is evaluated for the end of the first stage of bubble growth on heating surface (to say, to the end of the period of maximum dynamical influence of growing bubble). As a result following evaluation is derived with the kernel first obtained in [69]:

$$l \sim \frac{\sigma T_s \rho C_p}{(\rho_g r)^2} f_1(K) \quad (13)$$

Accordingly, Reynolds number is equal:

$$Re = \frac{\sqrt{P(v_g - v)} C_p \sigma \rho T_s}{(r \rho_g)^2 \nu} f_1(K) = Re_* f_1(K), \quad (14)$$

where modified Reynolds number comprises only physical parameters of boiling area:

$$Re_* = \frac{\sqrt{P(v_g - v)} C_p \rho T_s}{(r \rho_g)^2 \nu} \quad (15)$$

Finally functional relationship (11), through comparison with experimental data, acquires following form of equation of Shekrladze and Ratiani [17]:

$$Nu = 1.22 \cdot 10^{-2} K^{0.7} Re_*^{0.25} \quad (16)$$

It should be mentioned also that equation (15) for modified Reynolds number can be presented in more simple form, taking in account that specific work of expansion roughly always is equal to one tenth of specific heat of evaporation [$P(v_g - v) \approx 0.1r$]. In such a case simplified modified Reynolds number may be written in following form:

$$Re_{*,s} = \frac{C_p \sigma \rho T_s}{r^{3/2} \rho_g^2 \nu} \quad (17)$$

Accordingly, equation (16) can be transformed to the form previously presented in the first publication [17]:

$$Nu = 0.88 \cdot 10^{-2} K^{0.7} Re_{*,s}^{0.25} \quad (18)$$

In contrast to equation (16), no immediate dependence of HTC on saturation pressure of boiling area remains in actually the same equation (18). Thereby the fact is reflected that specific work of expansion, involving the pressure in (16), in reality represents specific heat of evaporation. Besides, as according (18) $Nu \sim [P(v_g-v)]^{1/8}$, calculation error connected with approximation $P(v_g-v) \approx 0.1r$ is quite insignificant.

CORRELATION OF EXPERIMENTAL DATA

Longstanding disregard of the role of effective radii of nucleation sites has led to essential incompleteness of overwhelming majority of experimental studies performed without measurement of characteristics of nucleation sites. In addition, absence of direct dependence of effective radius on standard roughness parameters makes unfeasible attempts to using of these parameters for characterization of influence of boiling surface on HTC.

Only very small part of numerous experimental works includes data on sizes and geometry of nucleation sites. It may be assessed as fortunate exclusion the work [53] including measurement of sizes and distribution of operating sites.

At the same time, in certain degree, the situation is mitigated by using in many experiments on boiling heat transfer of roughly identical commercial heating surfaces (mainly rolled tubes) roughly corresponding to one-parameter model of boiling surface.

Correlation of experimental data on HTC on heating surfaces with known ρ_0

Fortunately, a small number of experiments including the values of effective radii covers greatly differing boiling areas and materials of heating surfaces [53,96-98].

Boiling of water [53] is carried out on cooper surfaces with average effective radius of operating nucleation sites roughly equal to 5 μm . Boiling of sodium [96] is studied on stainless steel surface with uniform, rather big ($\rho_0=50\mu\text{m}$) stable artificial sites. Boiling of refrigerants [97] is studied on steel surface with big uniform artificial nucleation sites with effective radius equal to 86 μm . Boiling of nitrogen (purity – 98,12 %) is studied on sintered cooper porous surface [98] with mean effective radius of nucleation sites equal to 125 μm .

Correlation of experimental data [53,96-98] is presented in Figure 28. Presented correlation reflects support of adequacy of MTD by the most comprehensive experimental data. Below we should return to Figure 28 in regard to the problem of enhancement of boiling heat transfer.

Correlation of experimental data on developed boiling on commercial surfaces

In rough approximation commercial heating surfaces are characterized by the average effective radius of nucleation sites

equal to 5 μm in [17] based at some indirect evidences. As it is mentioned above this assumption is confirmed by comprehensive investigation [53] including experimental data on characteristics of operating nucleation sites.

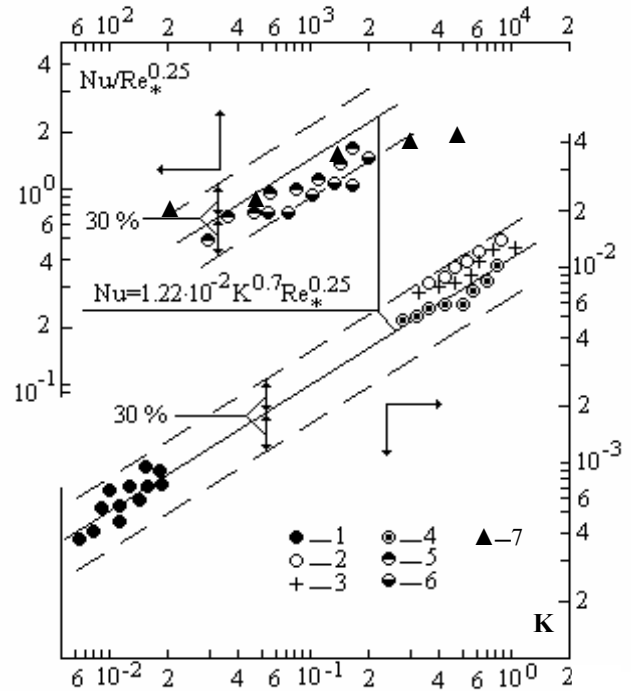

Figure 28. Comparison of equation.(16) with experimental data on developed boiling on the surfaces with the known values of ρ_0 : 1 – sodium [96], $\rho_0 = 50 \mu\text{m}$; 2-4 – water [53], $\rho_0 = 5 \mu\text{m}$; 5 – R 12 [97], $\rho_0 = 86 \mu\text{m}$; 6 - R 22 [97], $\rho_0 = 86 \mu\text{m}$; 7 – nitrogen [98], $\rho_0 = 125 \mu\text{m}$

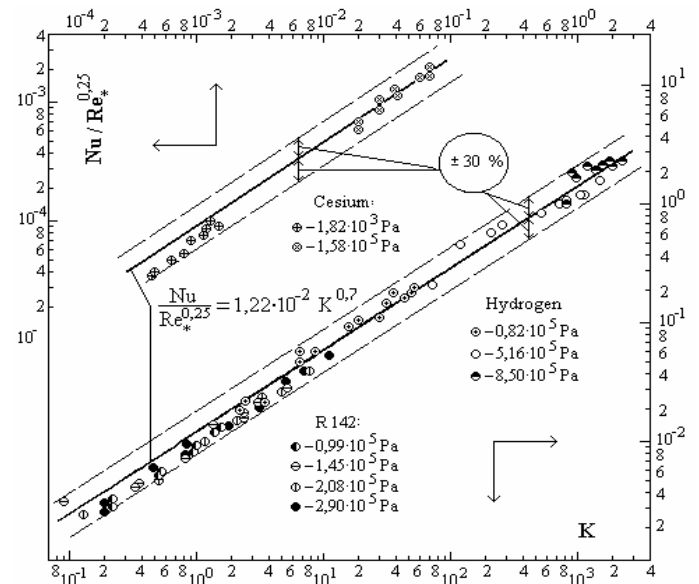

Figure 29. Correlation of experimental data on developed boiling of cesium [99], R 142 [100] and hydrogen [101] on commercial surfaces ($\rho_0 = 5 \mu\text{m}$ for all surfaces)

In figure 29, as an example, correlation of experimental data on boiling on commercial surfaces of one by one representative of the most "inconvenient" groups of liquids (liquid metals, refrigerants and cryogenic liquids) is presented.

It also presents significant interest correlation of the results of measurement of HTC during boiling of ammonia and 5 refrigerants on the same heating surface (platinum wire with diameter 0.3 mm) under different saturation pressures [54,107] (the wire is considered as commercial surface ($\rho_0 \approx 5 \mu\text{m}$)).

Important outcome of the correlation (Figure 30) is arrangement of all experimental data along unified heat transfer curve. The experimental data (related to the mode of developed boiling) corresponds to equation (16) with accuracy $\pm 30\%$.

As regards accuracy of correlation of experimental data related to commercial surfaces, it should be noted that accepted uniform average value of ρ_0 is only rather well-taken rough approximation. Really this parameter may vary in certain limits causing additional undefined error. For instance, accuracy of the correlation presented in Figure 30 may be improved up to $\pm 15\%$ using another value of effective radius ($\rho_0 \approx 3 \mu\text{m}$).

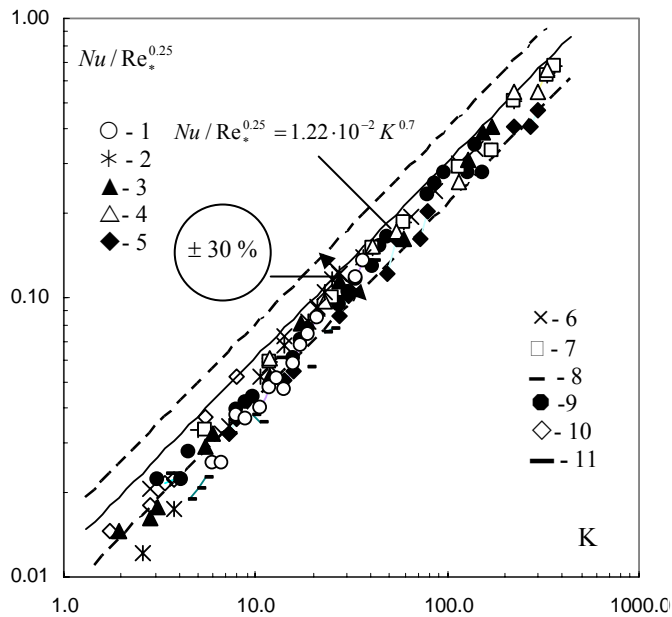

Figure 30. Correlation of experimental data on developed boiling of 6 different liquids on thin platinum wire: ammonia [54]: 1 - $4 \cdot 10^5$ Pa; 2 - $7 \cdot 10^5$ Pa; R11 [107]: 3 - $4 \cdot 10^5$ Pa; 4 - $7 \cdot 10^5$ Pa; R12 [107]: 5 - $4 \cdot 10^5$ Pa; R22 [107]: 6 - $4 \cdot 10^5$ Pa; 7 - $7 \cdot 10^5$ Pa; R113 [107]: 8 - $2.5 \cdot 10^5$ Pa; 9 - $4 \cdot 10^5$ Pa; R134a [107]: 10 - $2.5 \cdot 10^5$ Pa; 11 - $4 \cdot 10^5$ Pa

Equation (16) evidently has certain reserve of improvement of accuracy calling for detailed knowledge of nucleation sites. Heretofore we have to limit ourselves by rough evaluation of all commercial surfaces by uniform value of effective radius ($\rho_0 = 5 \mu\text{m}$). Thereby we avoid using of the existing uncertainty for fitting of experimental data to the recommended relationship.

Comparison of wide experimental data on developed boiling heat transfer with equation (16) is performed for all groups of liquids, including liquid metals and cryogenic liquids. In particular, the correlation involves experimental data on boiling HTC of water [91], R 12 [100], R 22 [100], R 142 [100], ethyl alcohol [102], benzene [103], biphenyl [103], sodium [104], cesium [99], potassium [93], mercury [105], CO [22], NO [22], BF_3 [22], ethane [106], ethylene [106], nitrogen [22,92], neon [101], hydrogen [101], helium [101], and others. The results of correlation are presented in the Appendix.

As it follows from the results of the comparisons the correlation (16) describes wide experimental data on developed boiling of all groups of liquids (water, organic liquids, refrigerants, cryogenic liquids, and liquid metals) without dividing of liquids into groups and without matching different constants and powers to different surface-liquid combinations. At that unified heat transfer law covers quite wide range of variation of the parameter K from 10^{-4} to 10^4 . Thereby unambiguously is demonstrated adequacy of MTD in context of comprehension of physical essence of studied phenomenon.

Finally, it presents certain interest discussion of some specific aspects of the correlation.

For instance, description of experimental data on ordinary liquids and liquid metals by unified equation reflects rather specific additional indication of superiority of MTD over MTA.

Known difficulties, arising through attempting unified dimensionless correlation of experimental data on heat transfer of ordinary liquids and liquid metals, is characteristic just for the case of dependence of HTC on intensities of concrete cooling mechanisms (to say, for the case of validity of MTA).

In contrast to it, just uniform nature and form of description of thermodynamic conditions, controlling heat transfer intensity according MTD (irrespective to kind of boiling liquid and shares of different cooling mechanisms) allow to removing the difficulties mentioned.

It also presents certain interest character of dependence of HTC on concrete parameters. According to equation (18):

$$h \sim q^{0.7} \rho_o^{0.4} k^{0.3} r^{0.325} C_p^{0.25} \sigma^{-0.45} T_s^{-0.45} \rho^{0.25} \rho_g^{0.2} v^{-0.25} \quad (19)$$

Presented composition of parameters and exponents hopefully turn to be useful through discussion of numerous MTA-based correlations in regard to influence of gravity field, contact angle, thermal conductivities of liquid and heating surface, and other parameters. As regards ρ_0 , having no analogues in MTA-based correlations, its role is discussed in the next subchapter.

Enhancement of boiling heat transfer

The line of development of high-efficient boiling surfaces presents a fortunate exception in the context of realization of the approaches and results [17].

The one-parameter model of boiling surface and correlation (16) determine the basic principle of boiling heat transfer enhancement through creation of numerous high-sized stable artificial nucleation sites with minimum worsening of thermal conductance of boiling surface. At the same time the

correlation (16) establishes boiling heat transfer enhancement law ($h \sim \rho_0^{0.4}$) quantitatively predicting achievable results.

During last decades enhanced boiling surfaces have been designed in one-to-one correspondence with this principle and heat transfer enhancement law. In this context it is reasonable to return to discussion of correlation of experimental data presented in Figure 28.

Main part of these experiments (related to heating surfaces with big artificial nucleation sites) just is targeted at heat transfer enhancement. Simultaneously they quantitatively verify predicted by equation (16) heat transfer enhancement law. Real enhancement factors, as compared with commercial surfaces, in these experiments achieve around 4 in the case of nitrogen, around 3 in the case of refrigerants and 2.5 in the case of sodium, in full accordance with equation (16).

At the same time sensible worsening of thermal conductance of boiling surface may not be avoided in all cases. For instance, creation of porous layer always is connected with increase of thermal resistance of heating surface. Besides, negative role of additional thermal resistance becomes more tangible with increase of heat flux. This is why in experiments [98] heat transfer enhancement factor reduces at high fluxes. Besides, similar low slope of boiling heat transfer curves is characteristic for a number of enhanced surfaces [108].

In this context the principle of minimum worsening of thermal conductance of boiling surface still remains topical through development of technologies of creation of enhanced boiling surfaces.

MTD AND MFC

As it follows from MTD and above correlations, developed boiling represents the most conservative basic regime of boiling heat transfer characterized by dependence of HTC on extremely restricted number of influencing factors. Besides, even interphase hydrodynamics and geometry (except of the micro-level) have no influence on HTC.

According equation (18), together with thermal parameters of boiling area, developed boiling HTC depends only on two "external" factors - heat flux and average effective radius.

As it follows from corresponding analysis, such a conservatism of developed boiling heat transfer can be linked to following three conditions:

- Existence of great (practically unlimited) number of stable nucleation sites with roughly uniform effective radii irrespective are they operating or potential;
- Short duration of each action of any cooling mechanism;
- Prevailing contribution of heat removal by liquid phase convection.

It should be noted also that in the context of presented conditions more concrete and narrower definition of the term "developed boiling" can be offered, just restricted by boiling processes corresponding to these conditions (to say, by the processes corresponding to MTD).

According to multifactoring concept (MFC) [36] any failure to meet these conditions leads to quite essential transformation of heat transfer regularities including drastic, supposedly, even explosive increase of the number of influencing HTC factors.

For instance, depending on concrete conditions, the circle of influencing HTC factors may be widened by parameters of interphase geometry and hydrodynamics, intensity of body force, contact angle, subcooling of liquid phase, sizes, form, orientation and thermal characteristics of heating surface, sizes, micro-geometry and distribution of nucleation sites, and prehistory of the process. Besides, boiling heat transfer multifactoring may be accompanied by drastic changes in heat transfer regularities, including "passing on the baton" from MTD to MTA.

Multifactoring, in such a manner, exhibits some characteristics of specific type of critical transition from developed boiling to qualitatively differing regimes of boiling heat transfer. As it follows from qualitative considerations, there can be distinguished two main types of multifactoring, the first – connected with presence of influence of a degree of penetration of liquid into nucleation site on effective radius of nucleation sites (wetting-dependent multifactoring), and the second – connected with transition to prolonged duration or uninterrupted regime of action of any intensive cooling mechanism (duration-dependent multifactoring).

Wetting-dependent multifactoring

Wetting-dependent multifactoring occurs in the case

$$\beta/2 > \theta, \quad (20)$$

when effective radius of any nucleation site stops to be a constant always equal to the radius of the mouth of the conical recess.

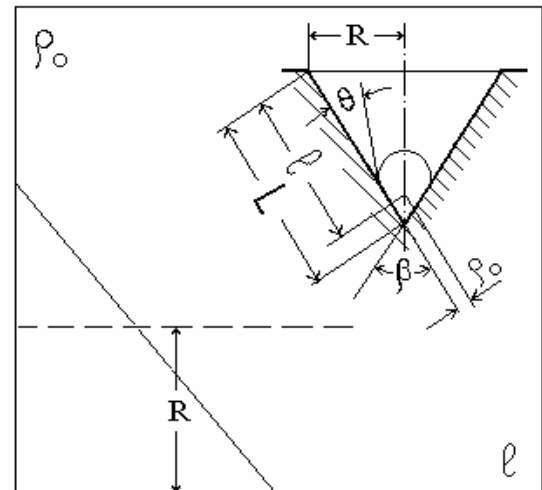

Figure 31. Dependence of effective radius on a degree of wetting of nucleation site by liquid phase in the case $\beta/2 > \theta$

Immediate transition from developed boiling to this type of multifactoring may be observed only in boiling system with reducing in time contact angle. In the majority of cases developed boiling and wetting-dependent multifactorous boiling of the same liquid may be observed only in separate boiling systems.

Dependence of effective radius on a degree of wetting of nucleation site by liquid phase in the case mentioned is presented in Figure 31.

As it can be shown through simple analysis, in this case effective radius of the site may be determined by following relationship:

$$\rho_0 = \frac{R}{\cos(\beta/2 - \theta)}(1 - l/L) \quad (21)$$

where geometrical parameters correspond to Figure 31.

As it follows from equation (21) effective radius undergoes wide-ranging variation with penetration of liquid into site. Besides, ρ_0 may be not only much less of R but even greater than R (in the case $l < L$).

As it was shown in [25], in this case, conditions of bubble growth onset in operating sites qualitatively differ from the conditions in potential ones. As transverse size of natural recess becomes much smaller far down from the mouth, the first onset of bubble growth in a potential site (liquid displacement from the very depth of the recess) requires much higher superheat than onset of any subsequent bubble growth (associated with the same process in upper part of the site after departure of preceding bubble).

In such a situation the transition of potential site to active condition and vice versa can occur only at markedly different superheats which in fact is the basis of the hysteresis phenomenon.

Wetting of the site, in general, represents dynamical process depending on velocity and time of wetting. These parameters, for its part, may be influenced by contact angle, heat flux, prehistory of the process, capability of heating surface to concentrate heat in the zone of wetting meniscus.

If wetting length l is small, under conditions considered, two highly differing levels of the parameter ρ_0 take place, the one of order of the radius of the mouth in operating sites and the other, very low one, in potential sites.

Corresponding so-called two-parameter model of boiling surface [25-26,30] turns to be fruitful through interpreting some specific families of heat transfer curves obtained in experiments on boiling of helium [110] (Figure 32).

Vertical line 1 corresponds to the process of simultaneous initiation of potential nucleation sites, with very small nuclei ($\rho_0 = \rho_{\min}$) deepened in the surface, determined by equation (3) (in this case, in nucleus zone, temperature gradient is negligible). Inclined line 2 corresponds to developed boiling according to the equation (16) for $\rho_0 = \rho_{\max}$.

Development of the process of boiling in the region of line 1 is accompanied by steep increase in the number of active nucleation sites. Besides, in connection with aforementioned

conclusion, decrease of the heat flux at any point of line 1 cannot lead to reduction of the number of operating nucleation sites in the rather wide range of variation of superheat.

In view of this, for any change in the heat flux, the process should follow without variation in the number of the operating sites, along the lines between the lines 1 and 2. In such a manner a prehistory of the process (degree of climb along line 1) predetermines the boiling curve that may be realized between boundaries 1 and 2.

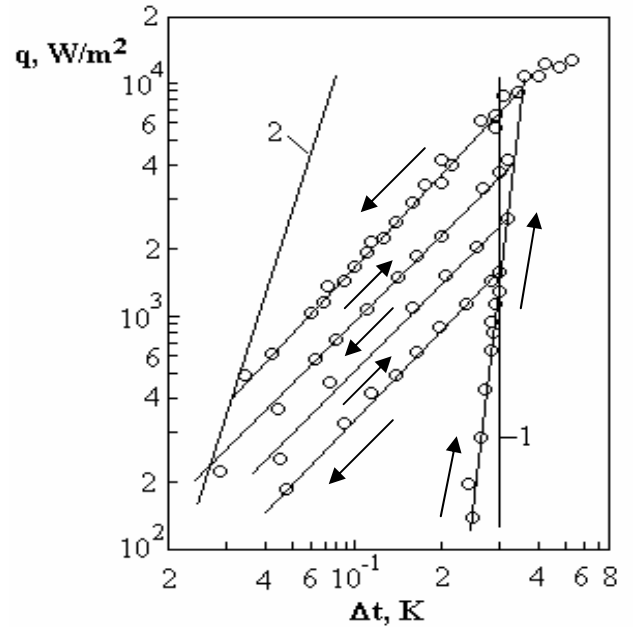

Figure 32. Boiling heat transfer curves for helium [110]: 1 - according equation (2), $\rho_0 = \rho_{\min} = 0.01 \mu\text{m}$; 2 - according equation (15), $\rho_0 = \rho_{\max} = 20 \mu\text{m}$

It should be noted also that the last comparison has qualitative character, since the actual values of ρ_{\max} and ρ_{\min} are unknown and have been selected on the condition of the best fit to experimental results ($\rho_{\min} = 0.01 \mu\text{m}$; $\rho_{\max} = 20 \mu\text{m}$).

At the same time, differing situation is to be observed on the heating surface providing stable and uniform effective radii of operating and potential sites even in the case $\theta = 0$. According MTD-MFC such a heating surface should not exhibit boiling heat transfer hysteresis. The last conclusion can be illustrated by experimental data [101] showing that boiling heat transfer hysteresis manifests itself vastly on rough surfaces and is virtually absent on polished ones.

As it follows from experimental data [53] (Figure 18) effective radii of recesses survived through polishing of cooper surface are almost at two orders of magnitude larger than standard roughness parameter of the same surface. Consequently, during the polishing process only the mouths of the recesses are polished and contracted that provides stable equality of effective radii to the radius of the mouth irrespective is the site operating or potential (to say, provides fulfilment of the condition (1) even in the case $\theta = 0$). According MTD the last circumstance excludes heat transfer hysteresis.

In the framework of MTD-MFC it also presents significant interest discussion of influence of thermal parameters of heating surface on HTC.

During developed boiling thermal parameters of heating surface have no influence on HTC (this conclusion is supported by the correlation presented in Figure 28).

In the context of wetting-dependent multifactoring, if process of wetting of a recess is accompanied by reduction of effective radius of nucleation site, restriction of this process evidently results elevation of HTC. High thermal conductivity of heating surface, promoting concentration of heat flow in the zone of wetting meniscus (in the extent additionally dependent on the thickness of the surface), just presents such a restricting factor.

Therefore, thermal parameters of heating surface, when its recesses correspond to condition (20), should essentially influence HTC during boiling, especially, during boiling of such perfectly wetting areas as cryogenic liquids. And vice versa, similar influence should not be exhibited by heating surfaces corresponding to condition (2) (to say, during developed boiling).

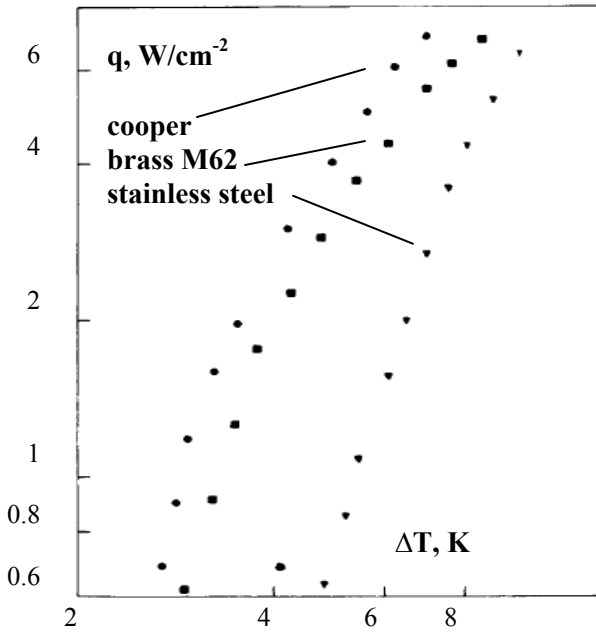

Figure 33. Boiling of nitrogen on rough heating surfaces made from cooper, brass and stainless steel [111]:

Experimental data [111] on boiling of nitrogen on comparatively rough heating surfaces (with the arithmetical mean roughness size around 5 μm) made from cooper, brass and stainless steel are presented in Figure 33. According to these data HTC essentially depends on thermal properties of heating surface that can be interpreted by dependence of effective radii of nucleation sites on the degree of penetration of the liquid phase into the sites.

Experimental data [112] on boiling of nitrogen on polished heating surfaces (smooth depth 0.2 μm in all cases) made from

cooper, brass and stainless steel are presented in Figure 34. According presented data HTC during boiling on aluminium and German Silver surfaces fall within scattering range of the data for cooper surface. Besides, thermal conductivity of cooper is around 20 times higher than the same parameter of German Silver.

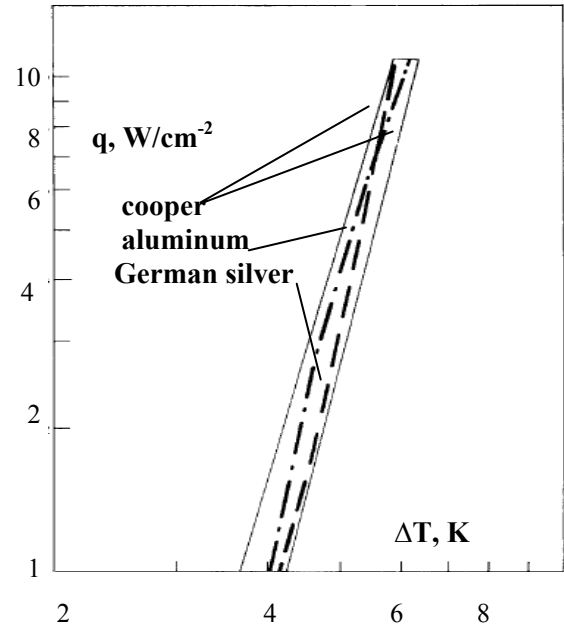

Figure 34. Boiling of nitrogen on polished heating surfaces made from cooper, German Silver and aluminum [112]:

Practically full absence of influence of thermal properties of heating surface on HTC on polished surfaces, similar to the hysteresis phenomenon, can be interpreted by existence of great number of stable nucleation sites satisfying condition (2).

In such a manner unified framework MTD-MFC leads to qualitative interpretation of diverse and even seemingly contradictory experimental facts connected with heat transfer hysteresis and influence of thermal parameters of heating surface. The same framework clearly outlines boundary between developed boiling and wetting-dependent multifactorous boiling.

Despite significant increase of the number of influencing factors, bubble growth onset preserves the role of regulator of average HTC. At the same time, in contrast to developed boiling, heat transfer gains significant new peculiarities quantitative description of which requires essential modification of MTD. In particular, it concerns initiation of dependence of effective radius (been independent constant during developed boiling) on several influencing factors.

Duration-dependent multifactoring

Duration-dependent multifactoring quite often may origin consequent to developed boiling, for instance, through transition to prolonged or even uninterrupted action of PEGB or microlayer evaporation with structural transformation of two-

phase flow. Similar transition also may take place with change of intensity of body force or with variation of inclination angle of heating surface in gravity field.

In contrast to wetting-dependent multifactoring, establishment of conditions of duration-dependent multifactoring is much more complex problem. Clarification of quantitative regularities of transition to prolonged action of cooling mechanisms in different boiling regimes, requiring consideration of structural development of corresponding two-phase flows, represents independent multifaceted problem.

At the same time, duration-dependent multifactoring results transition to heat transfer processes corresponding to MTA. Thereby, in connection with diversity of cooling mechanisms, the problem of theoretical assessment of HTC becomes extremely complex. It requires comprehensive multifactorous numerical modelling of all details and stages of operation of different cooling mechanisms (similar to attempt made in [109] for the case of subcooled flow boiling).

In the context of duration-dependent multifactoring it presents significant interest boiling in small channels.

Unfortunately, research of this important boiling process is affected by delay with development of adequate physical models comprehending basic peculiarities of the process. That is why attempts to establish efficient framework for correlation of existing experimental data on HTC and CHF still turn out to be unsuccessful [67-68]. There also are problems with correct choice of strategies of experimental research caused by the same absence of adequate physical models. For instance, it still insufficiently is taken in account essential role of thermal conductivity of heating surface in the processes with prevailing role of microlayer evaporation [15-16].

Similar to heat transfer hysteresis and influence of thermal parameters, there also exist contradictory experimental data on boiling in minichannels and microchannels. As it is mentioned above, part of the data shows accordance of heat transfer process to developed boiling and another part demonstrates qualitatively differing trends [64-68].

As it follows from qualitative analysis, seeming chaos in the experimental data, similar to cases considered above, can be resolved in the framework of MTD-MFC.

In general, geometry and transverse sizes of small-diameter channels support formation and longstanding preservation of vapour plugs shifting through a channel. As it is shown below, shifting vapour plug of very small diameter favours longstanding action of PEGB and microlayer evaporation mechanism. In this connection just transition to prolonged or even uninterrupted action of PEGB and microlayer evaporation claims to be main factors of multifactoring of boiling heat transfer in minichannels and microchannels. By the way, in this case PEGB should be named simply as pumping effect only because its action takes place without growth of vapour bubble.

Investigation of boiling multifactoring in small-diameter channel evidently presents extremely complex problem covering the stage of multifactoring itself and further regime of multifactorous heat transfer. Besides, in contrast to the steady-state process studied in [15-16], areas with intensive heat transfer are distributed in this case irregularly in space and in time.

In the context of duration-dependent multifactoring it presents significant interest clarification of the role of pumping effect in operation of pulsating heat pipe having quite specific peculiarities connected with self-start-up and keeping of pulsating two-phase flow [113-114].

As it follows from preliminary analysis, at very small diameter, very low thickness and possible partial drying of liquid layer between heating surface and the part of vapour plug create quite favourable conditions for strong manifestation of both related phenomena - microlayer evaporation and pumping effect. In contrast to pool boiling, in microchannel intensive action of the both mechanisms may turn out to be continuous (for instance, through shifting of evaporating meniscus along superheated wall).

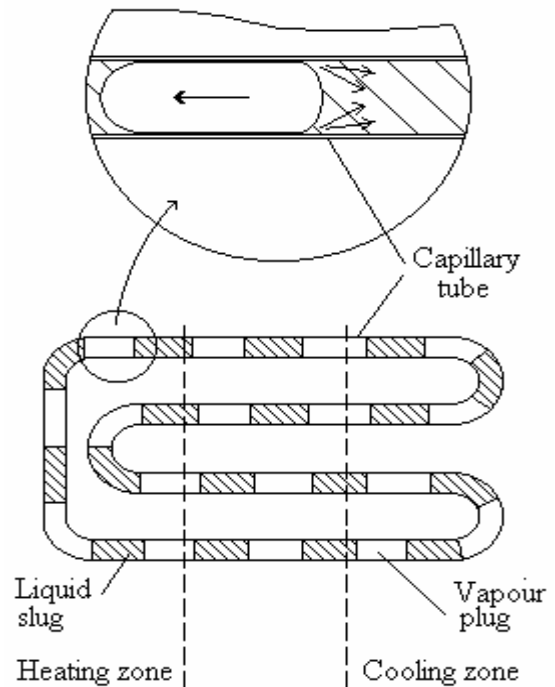

Figure 34. Pulsating heat pipe

In this context following working hypothesis can be offered regarding operation features of pulsating heat pipe [113-114] (Figure 34).

During heating in static conditions dynamical effects of jet flows on both sides of single vapour plug mainly balance each other and dynamical influence of the plug on two-phase system remains insignificant. However, this balance may be lost at any initial displacement of the plug (caused, for instance, by some instant pressure imbalance among different turns of pulsating heat pipe or by occurrence of temperature gradient along the plug).

The effect becomes stronger at backside of the plug (where the liquid layer becomes thinner) and it turns into certain type of jet engine continuing shifting through the channel with self-acceleration. Further this single plug displaces other plugs with the same dynamical effect and several plugs together speed-up circulation of heat carrier in the loop.

Start-up and acceleration of circulation rather quickly results return from cooling zone of the most cooled part of heat carrier. Condensation replaces evaporation on near to inlet plugs with change of the sign of pumping effect (nonuniform condensation also results pumping effect, although the effect is less intensive and maximum of dynamical recoil takes place on the cooler side of the plug). At the same time evaporation is weakened on other plugs.

Arising of opposite pumping effect, together with weakening of initial traction, quickly decelerates the circulation with consequent rise in temperature of heat carrier in heating zone. As a result, initial pumping effect is reshaped and described here sequence of stages is repeated periodically.

Offered here working hypothesis, with the exception of negative loop feedback aspects, is quite topical in regard boiling in minichannels and microchannels.

In particular, prolonged duration of intensive action of pumping effect and microlayer evaporation may create basis not only for boiling heat transfer multifactoring but for some specific dynamical effects as well.

For instance, it may be discussed the role of pumping effect in generation of strong reverse vapour flows, related cyclical oscillations and flow instabilities observed in minichannels and microchannels [68,115].

It may be shown that pumping effect of a certain vapour slug undergoes sharp intensification near to critical regime of channel flow (in connection with partial drying of liquid layer). Generated in such a way strong liquid jet flows may push off the next slug causing reverse of its own pumping effect. As a result, just similar slug may turn out to be responsible for aforementioned reverse vapour flows.

THE WAYS OF FURTHER RESEARCH

Modern state of art in boiling heat transfer research impressively demonstrates how longstanding disregard of adequate physical models and theories affects development of the problem including the choice of strategies of experimental investigations.

Fundamental boiling heat transfer problem - establishment of interrelations between diversity of boiling heat transfer curves and characteristics and distribution of nucleation sites – still remains left aside consideration.

Only very small part of numerous experiments includes investigation of nucleation sites. Unworkable attempts to substitute standard roughness parameters for the effective radii of nucleation sites are still underway.

Predicted forty years ago pumping effect of growing bubble (PEGB), despite impressive experimental evidences of its strength and crucial role in boiling heat transfer and crisis, still remains outside of scope of interests of overwhelming majority of researchers of the problem.

Widely published internationally universal MTD-based correlation, describing experimental data on HTC during developed boiling of all types of liquids (water, organic liquids, refrigerants, cryogenic liquids, liquid metals) without dividing of liquids into groups and without matching different constants and powers to different surface-liquid combinations, more than

four decades remains aside of consideration. Authoritative reviews of state of art in the field fail even to mention this correlation. It never is used for comparison with new experimental data by the researchers themselves.

Despite establishment of such a fundamental feature of developed boiling as independence of superheat of heating surface on qualitative changes in intensities of separate cooling mechanisms, it are still underway unfeasible attempts to describe developed boiling heat transfer through analysis of intensities of concrete cooling mechanisms.

During last years the author has initiated a discussion on these and other aspects of boiling problem [31-32,35-37]. Hopefully, the discussion and this lecture itself will serve for realistic evaluation of situation existed in the field of boiling heat transfer research.

At the same time, against the concerning background, existing situation possesses significant positive charge as well. It is connected with keeping in store of a lot of excellent tasks for young generation of boiling heat transfer researchers.

Wide theoretical and experimental investigations of PEGB are necessary by the goal of clarification of all spectra of important features of the effect beginning from generation of jet flow and ending by its dynamical and thermal consequences, including nongravity mechanism of vapour phase removal most likely playing leading role through boiling crisis at low saturation pressures and in microgravity, during forced convection boiling in minichannels and microchannels. At the same time it deserves certain interest investigation of micro-membrane pumping effect as additional convection cooling mechanism of nongravity nature.

It still remains as the central problem physical modelling of developed boiling of different liquids on one-parameter heating surfaces and on surfaces with more complex distribution of characteristic sizes and densities of nucleation sites in wide range of variation of effective radii, saturation pressure and other parameters.

Two possible lines of such a modelling deserve attention: artificial creation of boiling surfaces with designed parameters of nucleation sites and improvement of methods and apparatus for investigation of natural nucleation sites of different heating surfaces. Full-scale investigation of these processes in the framework MTD-MFC, together with refinement of MTD, may create basis for analysis of wide spectra of boiling heat transfer problems including quite interesting problem of the slope of developed boiling heat transfer curve.

It is important and capacious problem theoretical and experimental investigation of the phenomenon of multifactoring of boiling heat transfer in wide spectra of boiling processes in the framework of MTD-MFC.

Investigation of wetting-dependent and duration-dependent types of multifactoring should cover such an important aspects of boiling phenomenon as heat transfer hysteresis, heat transfer at variable average effective radii of nucleation sites, heat transfer processes with prolonged action of PEGB and microlayer evaporation including boiling in minichannels and microchannels, some specific regimes of boiling in subcooled liquids, in microgravity, on down facing boiling surfaces and others. Besides, investigation of transient behavior in the

framework MTD-MFC makes new potential for thorough insight into boiling phenomenon.

Among duration-dependent multifactorous boiling processes it deserves of special interest boiling in minichannels and microchannels. It is necessary to upgrade existing approaches to the problem in the framework MTD-MFC taking in account dynamical consequences of prolongation of intensive action of pumping effect.

Determined by correlation (16) and realized during last decades to a greater or lesser extent basic principle of intensification of boiling heat transfer - creation of numerous high-sized stable nucleation sites with minimum worsening of thermal conductance of boiling surface itself - still remains as the most efficient line of development of enhanced boiling surfaces. Correspondingly, improvement of corresponding technologies of manufacturing of boiling surfaces also should be targeted at possibly full realization of this principle.

REFERENCES

- [1] Moore, F.D., Mesler, R.B., The measurement of rapid surface temperature fluctuations during nucleate boiling of water, *A.I.Ch.E. Journal*, Vol. 7, pp. 620-624, 1961
- [2] Jacob, M., *Heat Transfer*, Vol. 1, Wiley, New York, 1949
- [3] Forster, H.K., Greif, R., Heat transfer in boiling liquid, mechanism and correlations, *Tr. ASME, J. Heat Transfer*, Vol. 81, pp. 43-53, 1959
- [4] Shekrladze, I.G., On the mechanism of nucleate boiling, *Bull. Acad. Sci. Georg. SSR.*, Vol. 41, pp. 392-396, 1966 (English version: *NASA TM X-59 398*, pp. 1-10, 1967)
- [5] Robin T.T. and Snyder N.W., Bubble dynamics in subcooled nucleate boiling based on the mass transfer mechanism, *Int. J. Heat Mass Transfer*, Vol. 13, pp. 305-318, 1970
- [6] Nesis, Ye.I., Sologub, I.S., Temperature fluctuations in subcooled boiling at a single site, *Kipenie i kondensatsia*, RPI Press, Riga, pp. 5-13, 1984
- [7] Tolubinski, V.I., Kriveshko, A.A., Ostrovski, Yu.N., About temperature fluctuations of the heating surface under the active nucleation site, *Teplofizika i teplotekhnika*, Vol. 19, pp. 22-26, 1971
- [8] Van Stralen, S J., Zijl, W., De Vries D.A., The behavior of vapor bubbles during growth at subatmospheric pressures, *Chem. Engng. Sci.*, Vol. 32, pp. 1189-1196, 1977
- [9] Shekrladze, I.G., Mestvirishvili, Sh.A., Rusishvili, J.G., Zhoszholiani, G.I., Ratiani, V.G., Study of heating surface temperature fluctuations in the process of liquid boiling, *Bull. Acad. Sci. Georg. SSR.*, Vol. 89, pp. 69-72, 1978
- [10] Judd, R.L., Hwang, K.S., A comprehensive model for nucleate pool boiling heat transfer including microlayer evaporation, *ASME J Heat Transfer*, Vol. 98, pp. 623-629, 1976
- [11] Thome, J.R., Latent and sensible heat-transfer rates in the boiling of binary mixtures, *ASME J Heat Transfer*, Vol. 104, pp. 474-478, 1982
- [12] Del Valle, M.V.H., Kenning, D.B.R., Subcooled flow boiling at high heat flux, *Int. J. Heat Mass Transfer*, Vol. 23, pp. 1907-1920, 1983
- [13] Tong, W., Bar-Cohen, A., Simon, T.W., Thermal transport mechanisms in nucleate pool boiling of high-wetting liquids, *Proc. 9th Int. Heat Transfer Conf.*, Vol. 2, pp. 27-32, 1990
- [14] Paul, D.D., Chiaasiaan, S.M., Abel-Khalik, S.I., On the contribution of various mechanisms to nucleate pool boiling heat transfer, *Pool and External Flow Boiling, ASME Proceedings 1992*, pp. 125-133, 1992
- [15] Ratiani, G.V., Mestvirishvili, Sh.A., Shekrladze, I.G., Analysis of two cases of evaporation from thin laminar films, *Bull. Acad. Sci. Georg. SSR.*, Vol. 55, pp. 325-328, 1969
- [16] Shekrladze, I.G., Rusishvili, J.G., Evaporation and condensation on grooved capillary surfaces, *Proc 6th Int. Heat Pipe Conf.*, Grenoble, pp. 234-239, 1987
- [17] Shekrladze, I.G., Ratiani, G.V., On the basic regularities of developed nucleate boiling heat transfer", *Bull. Acad. Sci. Georg. SSR.*, Vol. 42, pp. 145-150, 1966
- [18] Bard, L., Leonard, E.F., Heat transfer in simulated boiling, *Int. J. Heat Mass Transfer*, Vol. 10, pp. 1727-1734, 1967
- [19] Kutateladze, S.S., Malenkov, I.G., The hydrogasodynamic aspects of liquid boiling heat transfer, *Teplofizika Visokikh Temperatur*, Vol. 14, pp. 793-803, 1976
- [20] Shekrladze, I.G., On the role of the "pumping effect" of a vapour bubble growing at the wall during nucleate boiling, *Problems of Convection Heat Transfer and Steam Purity*, Metsniereba Press, Tbilisi, pp. 90-97, 1970
- [21] Ratiani, G.V., Shekrladze, I.G., Study of the process of fully developed boiling of liquids, *Heat Transfer-Soviet Research*, Vol. 4, pp. 126-141, 1972
- [22] Shekrladze, I. G., Rusishvili, J. G., Experimental study of heat transfer during boiling and condensation of cryogenics, *Ingenerno-Physicheski Journal*, Vol. 33, pp. 486-490, 1977
- [23] Shekrladze, I.G., Mestvirishvili, Sh.A., Rusishvili, J.G., Zhoszholiani, G.I., Ratiani, V.G., Studies in the mechanism of boiling and enhancement of evaporative cooling coefficients, *Heat Transfer-Soviet Research*, Vol. 12, pp. 91-95, 1980
- [24] Shekrladze, I. G., On the nongravity mechanism of vapour removal in the process of boiling, *Bull. Acad. Sci. Georg. SSR.*, Vol. 100, pp. 81-84, 1980
- [25] Shekrladze, I. G., On the mechanism of heat transfer hysteresis in the process of boiling", *Bull. Acad. Sci. Georg. SSR*, Vol. 101, pp. 325-328, 1981
- [26] Shekrladze, I.G., Developed boiling heat transfer, *Int. J. Heat Mass Transfer*, Vol. 24, pp. 795-801, 1981
- [27] Shekrladze, I.G., Heat transfer in two-phase areas with intensive evaporation and condensation, Tesis of Dr. Tech. Sc., Moscow Bauman Highest Technical School, Moscow, 1982
- [28] Shekrladze, I. G., Verulava, Yu. Sh., Vasadze, L. Ye., Paniashvili, M. S., An experimental investigation of heat transfer and critical heat fluxes during Boiling of organic working bodies and water under reduced pressures, *J. Engng. Phys.*, Vol. 42, pp. 689-693, 1982
- [29] Shekrladze, I. G., Developed boiling heat transfer of cryogenic liquids and refrigerants, *Heat and Mass Transfer in Refrigeration and Cryogenics*, Hemisphere, Washington, pp. 580-591, 1987
- [30] Shekrladze, I.G., Mechanisms of heat removal in the process of developed boiling, *Heat Transfer-Soviet Research*, Vol. 22, pp. 445-463, 1990
- [31] Shekrladze, I.G., Frozen pathways to breakthrough in boiling heat transfer theory, *Proc. 11th Int. Heat Transfer Conference*, Vol. 2, pp. 474-478, 1998
- [32] Shekrladze, I. G., Comments on the paper "Jet flow phenomena during nucleate boiling", *Int. J. Heat Mass Transfer*, Vol. 46, pp. 2711-2712, 2003
- [33] Shekrladze, I. G. Rusishvili, J.G., Gigineishvili, G.G., Machavariani, E.S., Shekrladze, D.I., Boiling of liquid wetting open capillary grooves of heating surface, *IASME Transactions*, Vol. 2, pp. 1762-1770, 2005
- [34] Shekrladze, I. G. Rusishvili, J.G., Gigineishvili, G.G., Machavariani, E.S., Shekrladze, D.I., Boiling hat transfer on grooved capillary surfaces, *Proc. 3rd IASME/WSEAS Int. Conf. Heat*

- Transfer, Thermal Engineering and Environment* Corfu, pp. 283-287 (CD), 2005
- [35] Shekrladze, I.G., Rusishvili, J.G., Comments on papers L. Pioro, W. Rosenow, S. S. Doerfer "Nucleate pool-boiling heat transfer, 1: review of parametric effects of boiling surface; 2: assessment of prediction methods", *Int. J. Heat Mass Transfer*, Vol. 49, pp. 1205-1207, 2006
- [36] Shekrladze, I.G., Developed boiling heat transfer – forty years of the model of “the theatre of director”, *Proc. 13th Int. Heat Transfer Conf.*, Sydney, pp. 1-12 (CD), 2006
- [37] Shekrladze, I.G., Discussion: “Dynamics of bubble motion and bubble top jet flows from moving vapour bubbles on microwires”, *ASME J Heat Transfer*, Vol. 127, pp. 1260-1261, 2006
- [38] Schlichting, H., *Boundary-Layer Theory*, McGraw-Hill, NY, 1979
- [39] Subbotin, V.I., Kaznovski, S.P., Korotaev, S.K., Investigation of the dynamics of vapour bubbles in boiling of water on thin wires under natural convection, *Atomnaia Energia*, Vol. 28, pp. 9-13, 1970
- [40] Afgan, O.N., *Boiling Liquids Superheat*, Pergamon Press, Oxford, 1976
- [41] Wang, H., Peng, X., Christopher, D.M., X.F., Wang, B.X., Lee, D.J., Jet flow phenomena during nucleate boiling, *Int. J. Heat Mass Transfer*, Vol. 45, pp. 1359-1363, 2002
- [42] Wang, H., Peng, X., Christopher, D.M., W.K. Lin, Pan, C., Investigation of bubble-jet flow during subcooled boiling on wires, *Int. J. Heat Fluid Flow*, V. 26, pp. 485-494, 2005
- [43] Wang, H., Peng, X., Christopher, D. M., Garimella, S.V., Jet flows around microbubbles in subcooled boiling, *ASME J. Heat Transfer*, V 127, pp. 802, 2005
- [44] McGraw, J.L., Bamford, F.L., Rehm, T.R., Marangoni flow: additional mechanism in boiling heat transfer, *Science*, Vol. 153, pp. 1106-1107, 1966
- [45] Betz, J., Straub, J., Numerical and experimental study of the heat transfer and fluid flow by thermocapillary convection around gas bubble, *Heat Mass Transfer*, Vol. 37 (2), pp. 215-227, 2001
- [46] Christopher, D.M., Wang, H., Peng, X., Dynamics of bubble motion and bubble top jet flows from moving vapor bubbles on microwires, *ASME J. Heat Transfer*, Vol. 127, pp. 1260-1268, 2005
- [47] Rose, J.W., Interphase matter transfer, the condensation coefficient and dropwise condensation, *Proc. 11th Int. Heat Transfer Conference*, Kyongju, Korea, Vol. 1, pp. 89-104, 1998
- [48] Kutateladze, S.S., *Heat Transfer in Condensation and Boiling*, Mashgiz, Moscow., 1952
- [49] Clark, D.A., Cryogenic heat transfer, *Uspekhi Teploperedachi*, Mir Press, Moscow, pp. 361-567, 1971
- [50] Straub, J., Zeil, M., Vogel, B., Pool boiling in a reduced gravity field, *Proc. 9th Int. Heat Transfer Conference*, Vol. 1, pp. 91-112, 1990
- [51] Oka, T., Abe, Y., Mori, Y.H., Nagashima, A., Pool boiling of n-pentane, CFC, and water under reduced gravity: parabolic flight experiments with a transparent heater, *ASME J Heat Transfer*, Vol. 117, pp. 408-417, 1995
- [52] Subbotin, V.I., Sorokin, D.N., Ovechkin, D.M., Kudriavtsev, A.P., *Heat Transfer during Pool Boiling of Metals*, Nauka Press, Moscow, 1969
- [53] Shoukri, M., Judd, R.L., Nucleation site activation in saturated boiling, *J. Heat Transfer*, Vol. 97, pp. 96-102, 1975
- [54] Arima, H., Monde, M., Mitsutake, Y., Heat transfer in pool boiling of ammonia/water mixture, *Int. J. Heat Mass Transfer*, Vol. 45, pp. 4409-4415, 2002
- [55] Ziegel, R., *Heat Transfer Under Reduced Gravitation*, Mir Press, Moscow, 1970
- [56] Voloshko, A.A., Effects of microgravity and dynamic acceleration on physical characteristics and heat transfer intensity under liquid boiling, *Proc. Int. Symp. Physics Heat Transfer Boiling Condensation*, MEI Press, Moscow, pp. 557-560, 1996
- [57] Butuzov, A.I., Faisilberg, S.N., Bezrodny, M.K., Stogny, N.I., Kudelia, P.P., Usenko, V.I., Experimental data on pool Boiling of refrigerant-12 and water under inertial reloading, *Teplofizika visokikh temperatur*, Vol. 7, pp. 490-494, 1969
- [58] Kim, J., Benton, J.F., Highly subcooled pool boiling heat transfer At various gravity levels, *Int. J. Heat Fluid Flow*, Vol. 23, pp. 497-508, 2002
- [59] Kim, J., Benton, J.F., Wisniewski Derek, Pool boiling heat transfer on small heaters: effect of gravity and subcooling, *Int J Heat Mass Transfer*, Vol. 45, pp. 3919-3932, 2002
- [60] Hwang, T.H., Yao, S.C., Forced convective boiling in horizontal tube bundles, *Int. J. Heat Mass Transfer*, Vol. 29, pp. 785-795, 1986
- [61] Zaigarnik, Yu.A., Forced convection boiling, in: *Int. Encyclopedia of Heat and Mass Transfer*, CRC Press, Boca Raton, pp. 464-467, 2000.
- [62] Nishikava, K., Fujita, Y., Uchida, S., Ohta, H., Effect of surface configuration on nucleate boiling heat transfer, *Int. J. Heat Mass Transfer*, Vol. 27, pp. 3919-3932, 1984
- [63] Parker, J.L., El-Genk, M.S., Effect of surface orientation on nucleate boiling of FC-72 on porous graphite, *ASME J. Heat Transfer*, Vol. 128, pp. 1559-1571, 2006
- [64] Mehendale, S.S., Jacobi, A.M., Evaporative heat transfer in mesoscale heat exchangers, *ASHRAE Trans.*, Vol. 106, pp. 446-452, 2000
- [65] Bergles, A.E., Leinhard, V.J. H., Kendall, G.E., Griffith, P., Boiling and evaporation in small diameter channels, *Heat Transfer Engineering*, Vol. 24, pp. 18-40, 2003
- [66] Thome, J.R., Groll, M., Mertz, R., Microscale Heat transfer: boiling and evaporation, *Heat Exchanger Design Update*, Begell House, NY, 2.13.4.1-27, 2003
- [67] Kandlikar, S., *Heat Transfer and Fluid Flow in Minichannels and Microchannels*, Elsveier, London, 2006
- [68] Thome, J.R., Fundamentals of boiling and two-phase flow in micrichannels, *Proc. 13th Int. Heat Transfer Conf.*, Sydney, pp. 1-22 (CD), 2006
- [69] Kruzhilin, G.N., Heat transfer from heating surface to boiling single-component liquid in conditions of natural convection, *Izvestia AN SSSR, OTN*, Vol. 7, pp. 967-980, 1948
- [70] Rohsenow W.M., A Method of correlating heat transfer data for surface boiling of liquids, *Trans. ASME*, Vol. 74, pp. 969-976, 1952
- [71] Tolubinski, V.I., The problem of boiling heat transfer theory, *Izvestia VUZ, Energetika*, Nr. 1, pp. 15-22, 1959
- [72] Kurihara, H.M., Meyers, J.E., The effects of superheat and surface roughness on boiling coefficients, *AIChE Journal*, Vol. 6, pp. 83-91, 1960
- [73] Leinhard, J.H., A Semi-rational nucleate boiling heat flux correlation, *Int. J. Heat Mass Transfer*, Vol. 6, pp. 215-219, 1963
- [74] Zuber, N., Nucleate boiling: region of isolated bubbles and the similarity with natural convection, *Int. J. Heat Mass Transfer*, Vol. 6, pp. 53-78, 1963
- [75] Kutateladze, S.S., Leontiev, A.I., Kirdiashkin, A.G., Nucleate boiling heat transfer theory, *Ingenerno-Physichesi Jurnal*, Vol. 8, pp. 7-12, 1965
- [76] Micic, B.B., Rohsenow, W.M., A New correlation of pool-boiling data including the effect of heating surface characteristics, *J. Heat Transfer*, Vol. 91, pp. 245-250, 1969
- [77] Labuntsov, S.A., Problem of heat transfer during nucleate boiling of liquids, *Teploenegretika*, Nr. 9, pp. 14-19, 1972
- [78] Stephan, K., Abdelsalam, M. Heat transfer correlations for natural convection boiling, *Int. J. Heat Mass Transfer*, Vol. 23, pp. 73-87,

1980

- [79] Kandlikar, S.,A., General correlation for saturated two-phase flow boiling heat transfer inside horizontal and vertical tubes", *Journal of Heat Transfer*, Vol. 112, pp. 219-228, 1990
- [80] Pasamehmetoglu, K.O., Chappidi, P.R., Unal, C., Nelson, R.A., Saturated pool nucleate boiling mechanisms at high heat fluxes, *Int. J. Heat Mass Transfer*, Vol. 36, pp. 3859-3868, 1993
- [81] Haider, S.I., Webb, R.L., A transient micro-convection model of nucleate pool boiling, *Int. J. Heat Mass Transfer*, Vol. 40, pp. 3675-3688, 1997
- [82] Dhir, V.K., Numerical simulation of pool-boiling heat transfer, *AIChE Journal*, Vol. 47, pp. 813-834, 2001
- [83] He, Y., Shoji, M., Maruyama, Sh., Numerical study of high heat flux pool boiling heat transfer, *Int. J. Heat Mass Transfer*, Vol. 44, pp. 2357-2373, 2001
- [84] Fuchs, T., Kern, J., Stephan, P., A transient nucleate boiling model including microscale effects and wall heat transfer, *Journal of Heat Transfer*, Vol. 128, pp. 1257-1265, 2006
- [85] Piroo, I.L., Rohsenow, W.M Doerffer, S.S., Nucleate pool-boiling heat transfer, 1: review of parametric effects of boiling surface, *Int. J. Heat Mass Transfer*, Vol. 47, pp. 5033-5044, 2004
- [86] Piroo, I.L., Rohsenow, W.M., Doerffer, S.S., Nucleate pool-boiling heat transfer, 2: assessment of prediction methods, *Int. J. Heat Mass Transfer*, Vol. 47, pp. 5045-5057, 2004
- [87] Dhir, K.V., Mechanistic prediction of nucleate boiling heat transfer - achievable or hopeless task? *ASME J Heat Transfer*, Vol. 128, pp. 1-12, 2006
- [88] Griffith, P., Wallis, S. D., The role of surface conditions in nucleate boiling, *Chem. Engng. Progr. (symp. ser.)*, Vol 56, pp. 49-60, 1960
- [89] Madejski, M., Activation of nucleation cavities on a heating surface with temperature gradient in a superheated liquid, *Int. J. Heat Mass Transfer*, Vol. 9, pp. 295-300, 1966
- [90] Luikov, A.V., *Heat Conduction Theory*, Visshaia Shkola Press, Moscow, 1967
- [91] Borishanski, V.M., Kozirev, A.P., Svetlova, A.S., Investigation of heat transfer during nucleate boiling of liquids, *Convection Heat Transfer and Hydrodynamics in Two-Phase and Single-Phase Flows*, Gosenergoizdat Press, Moscow, pp. 71-104, 1964
- [92] Dudkevich, A.C., Akhmedov, F.D., Experimental study of influence of thermophysical properties of heating surface on boiling of nitrogen at elevated pressures, *Trudi, MEI*, Issue 198, pp. 41-47, 1974
- [93] Borishanski, V.M., Kutateladze, S.S., Novikov, I.I., *Liquid Metal Heat Carriers*, Atomizdat Press, Moscow, 1967
- [94] Chai, L. H., Shoji, M., Self-organization and self-similarity in boiling systems, *J. Heat Transfer*, Vol. 124, pp. 507-515, 2002
- [95] Chai, L.H., Shoji, M., Closure to "Discussion to "Self-organization and self-similarity in boiling systems", *J. Heat Transfer*, Vol. 126, pp. 663-664, 2005
- [96] Marto, P.L., Rohsenow, W.M., Effects of surface conditions on nucleate pool boiling of sodium, *Journal of Heat Transfer*, Vol. 88, pp. 149-157, 1966
- [97] Chumak, L.V., Malaia, L.V., Vinichenko, I.V., Enhancement of heat transfer of cryogenics on the pipe surface", *Kholodilnaia tekhnika*, No 2, pp. 31-34, 1979
- [98] Xiulin, Y., Hongji, X., Yuweng, Z., Hongzhang, Q., Pool boiling heat transfer to liquid nitrogen from porous metallic coatings of tube bundles and experimental research of hysteresis phenomenon, *Cryogenics*, Vol. 29, pp. 460-462, 1989
- [99] Subbotin V. I., Ovechkin, D. M., Sorokin, D. N., Heat transfer during pool boiling of cesium, *Teploenergetika*, Vol. 6, pp. 63-66, 1968
- [100] Danilova, G.N., Influence of saturation pressure and temperature on heat transfer during boiling of refrigerants, *Trudi CKTI*, Vol. 57, pp. 69-80, 1965
- [101] Grigoriev, V.A., Pavlov, Yu.M., Ametistov, E.V., *Boiling of Cryogenic Liquids*, Energia Press, Moscow, 1973
- [102] Borishanski, V.M., Bobrovich, G.I., Minchenko, F.P., Heat transfer during boiling of water and ethyl alcohol at external surface of tubes, *Problems of Heat Transfer and Hydrodynamics in Two-Phase Area*, Gosenergoizdat Press, Moscow, pp. 75-93, 1961
- [103] Hene, Guber, 1963, "Boiling of benzene, biphenyl and benzene-biphenyl mixtures", *Journal of Heat Transfer*, Vol. 85, pp. 31-38 (Russian Translated Edition)
- [104] Petukhov, B.S., Kovalev, S.A., Zhukov, V.M., Study of sodium boiling heat transfer, *Proc. 3rd Int.Heat TransferrConf.*, Hemisphere, NY, Vol. 5, pp. 80-91, 1966
- [105] Pridantsev, A.I., Kokorev, L.S., Deev, V.I., Petrovichev V.I., Experimental study of regimes and heat transfer during boiling of mercury under subatmospheric pressures, *Problems of Thermophysics of Nuclear Reactors*, Atomizdat Press, Moscow, Issue 3, pp. 3-12, 1971
- [106] Kravchenko, V.A., Tolubinskaia, L.F., Heat transfer during boiling of ethan and ethylene, *Teplofizika i Teplotekhnika*, Issue 31, pp. 61-64, 1976
- [107] Inoue, T, Kavae., N., Monde, M., Characteristics of heat transfer coefficient during nucleate pool boiling of binary mixtures, *Heat and Mass Transfer*, Vol. 33, pp. 337-344, 1998
- [108] Webb, R.L., Pais, Ch., Nucleate pool boiling data for five refrigerants on plain, integral-fin and enhanced tube geometries, *Int J. Heat Mass Transfer*, Vol. 35, pp. 1893-1904, 1992
- [109] Basu, N., Warriar, G.R., Dhir, V.K., Wall heat flux partitioning during subcooled flow boiling, *J. Heat Transfer*, Vol. 127, pp. 131-140, 2005
- [110] Andreyev, V.K., Deyev, V.I., Petrovichev, V.I., Shelukhina, G.S., Heat transfer regimes in bubble pool boiling of helium, *Teplofizika visokikh temperatur*, Vol. 16., pp. 882-884, 1978
- [111] Grigoriev, V.A., Pavlov, Yu.M., Ametistov, E.V., Klimenko, A.V., Klimenko, V.V., Concerning the influence of thermal properties of heating surfacce material on heat transfer intensity of nucleate pool boiling of liquids including cryogenic ones, *Cryogenics*, Vol. 17., pp. 94-96, 1977
- [112] Ackerman, H., Bewilogua, B., Vinzelberg, H., Bubble boiling from heated surface of different material in liquid nitrogen, *Cryogenics*, Vol. 15., pp. 877-678, 1975
- [113] Yang, H., Khandekar, S., Groll, M., Operational limit of closed loop pulsating heat pipes, accepted manuscript, *Applied Thermal Engineering*, 2007
- [114] Qu, W., Ma, H.B. Theoretical analysis of start-up of pulsating heat pipe, *Int. J. Heat Mass Transfer*, Vol. 50, pp. 2309-2316, 2007
- [115] Ping Cheng, Hui-Ying Wu, Fang-Jun Hong, Phase-change heat transfer in microsystems, *Journal of Heat Transfer*, Vol. 129, pp. 101-108, 2007

CORRELATION OF EXPERIMENTAL DATA

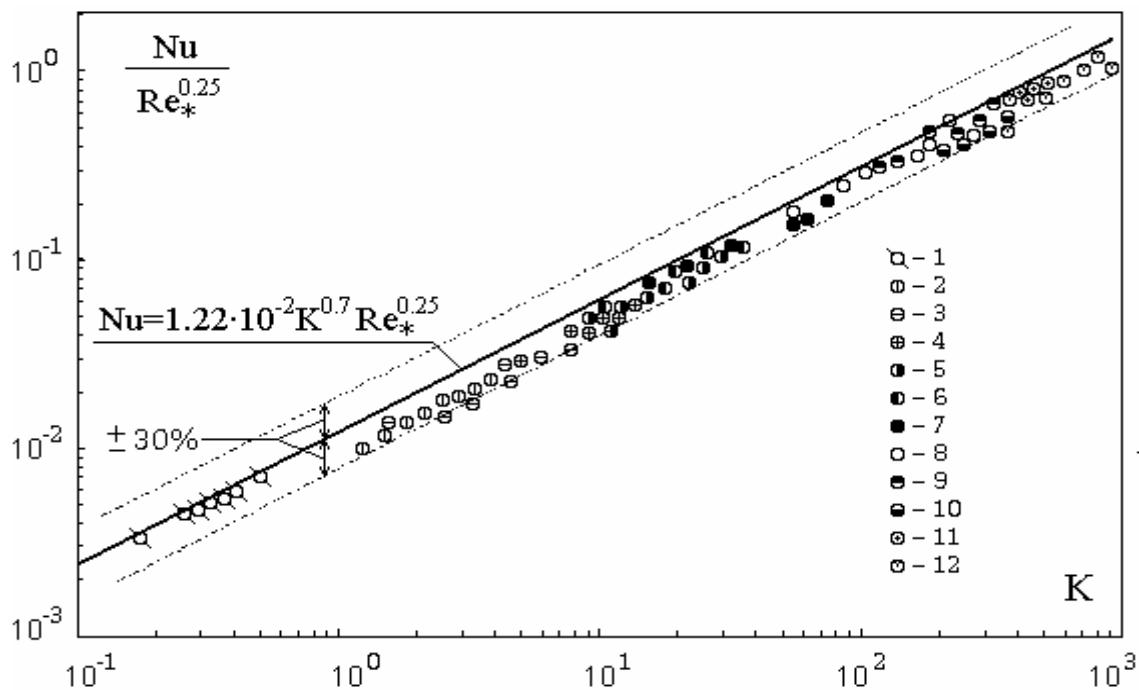

Figure 1. Correlation of experimental data on developed boiling of water [91] on commercial surfaces: 1 - 0.1 MPa; 2 - 0.6 MPa; 3 - 1.05 MPa; 4 - 2.3 MPa; 5 - 3.2 MPa; 6 - 4.3 MPa; 7 - 5.6 MPa; 8 - 10.1 MPa; 9 - 13.1 MPa; 10 - 15.0 MPa; 11 - 17.2 MPa; 12 - 18.2 MPa.

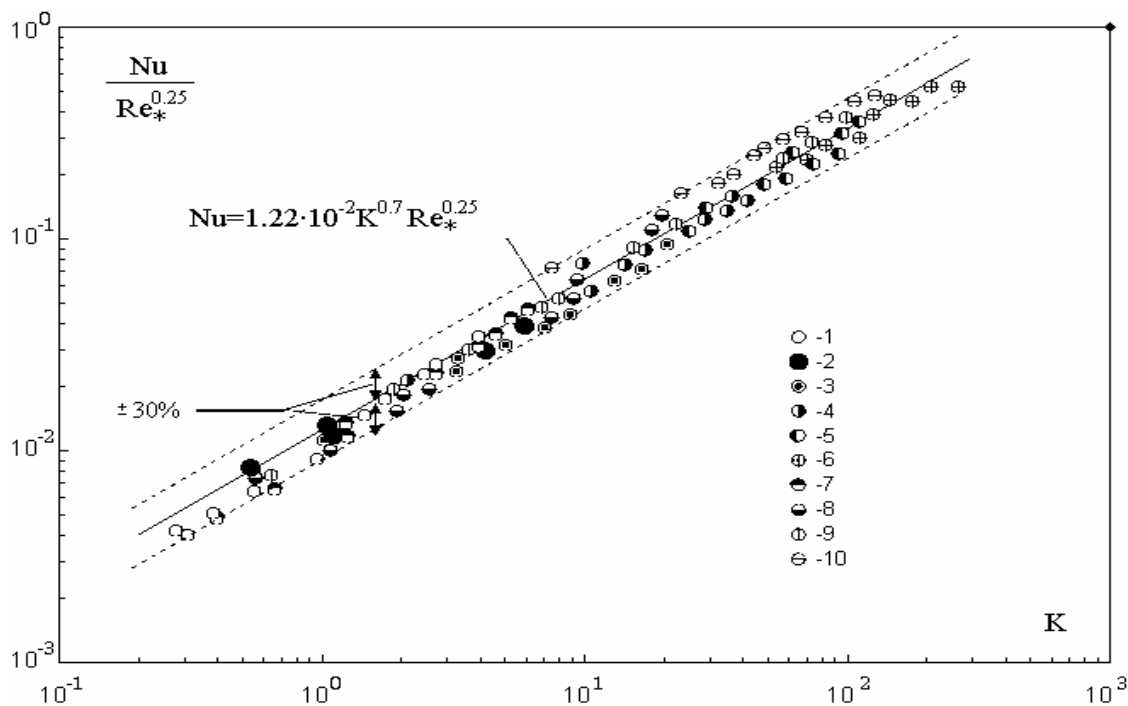

Figure 2. Correlation of experimental data on developed boiling of ethyl alcohol [102] on commercial surface: 1 - 0.1 MPa; 2 - 0.3 MPa; 3 - 0.5 MPa; 4 - 0.7 MPa; 5 - 1.0 MPa; 6 - 1.47 MPa; 7 - 1.95 MPa; 8 - 2.34 MPa; 9 - 3.94 MPa; 10 - 4.94 MPa; 11 -

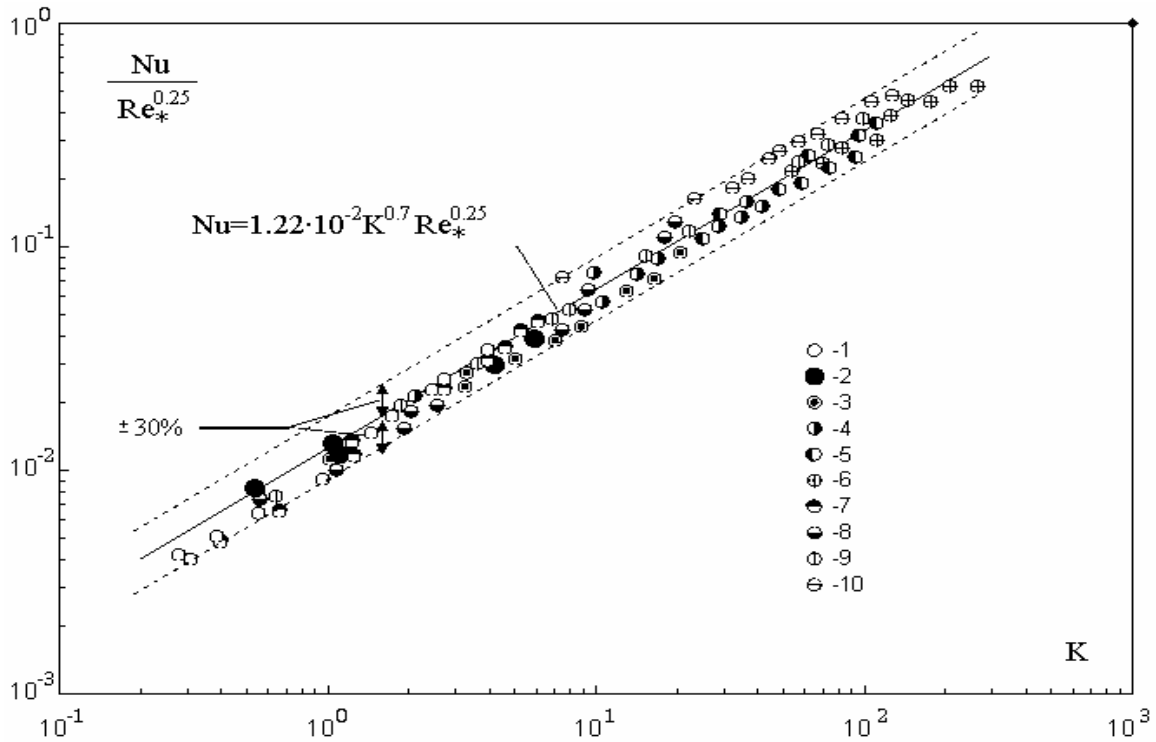

Figure 3. Correlation of experimental data on developed boiling of benzene [103] and biphenyl [103] on commercial surfaces benzene: 1 - 0.093 MPa; 2 - 0.248 MPa; 3 - 0.353 MPa; 4 - 0.8 MPa; 5 - 1.38 MPa; 6 - 2.07 MPa; biphenyl: 7 - 0.093 MPa; 8 - 0.248 MPa; 9 - 0.353 MPa; 10 - 0.8 MPa

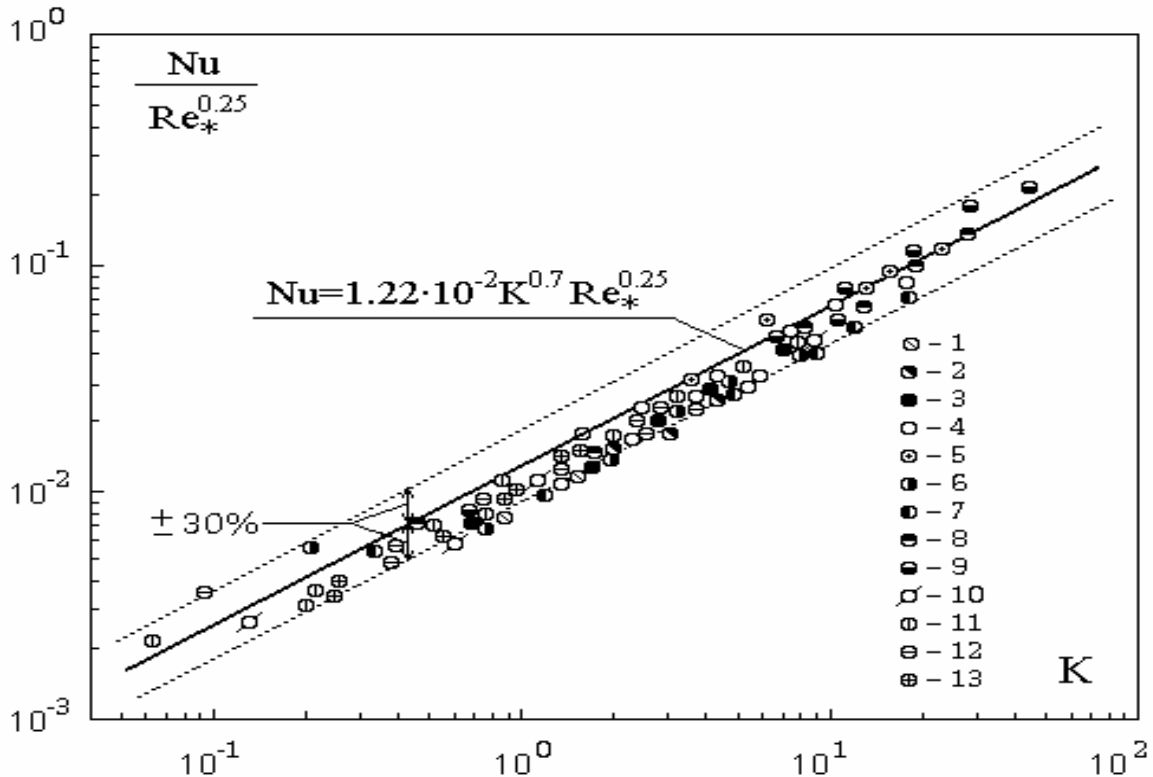

Figure 4. Correlation of experimental data on developed boiling of refrigerants on commercial surfaces: R12 [100]: 1 - 0.17 MPa; 2 - 0.22 MPa; 3 - 0.31 MPa; 4 - 0.42 MPa; 5 - 0.56 MPa; R22 [100]: 6 - 0.355 MPa; 7 - 0.57 MPa; 8 - 0.68 MPa; 9 - 0.92 MPa; R142 [100]: 10 - 0.1 MPa; 11 - 0.145 MPa; 12 - 0.21 MPa; 13 - 0.29 MPa

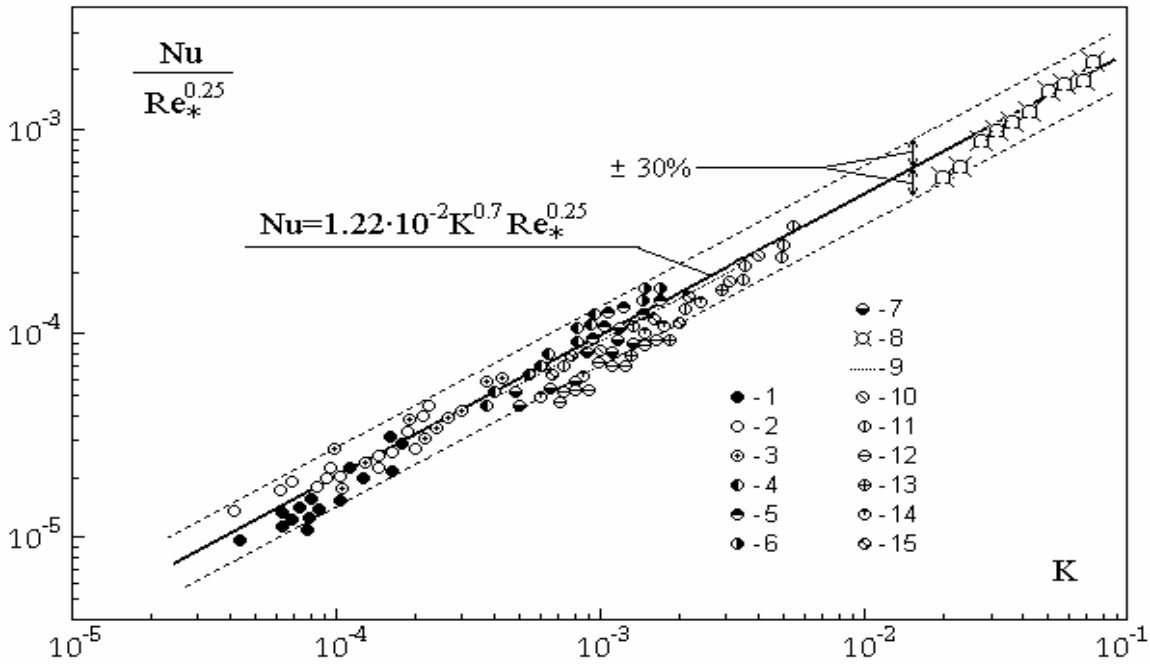

Figure 5. Correlation of experimental data on developed boiling of liquid metals on commercial surfaces: sodium [104]: 1 - 2.66 kPa; 2 - 4.65 kPa; 3 - 9.31 kPa; 4 - 23.9 kPa; 5 - 35.9 kPa; 6 - 46.5 kPa; cesium [99]: 7 - 2.0 kPa; 8 - 0.16 MPa; potassium [93]: 9 - $\alpha = 3 \cdot P^{0.15} q^{0.7}$; mercury [105]: 10 - 0.0435 MPa; 11 - 0.0572 MPa; 12 - 0.0117 MPa; 13 - 0.08 MPa; 14 - 0.018 MPa; 15 - 0.0346 MPa

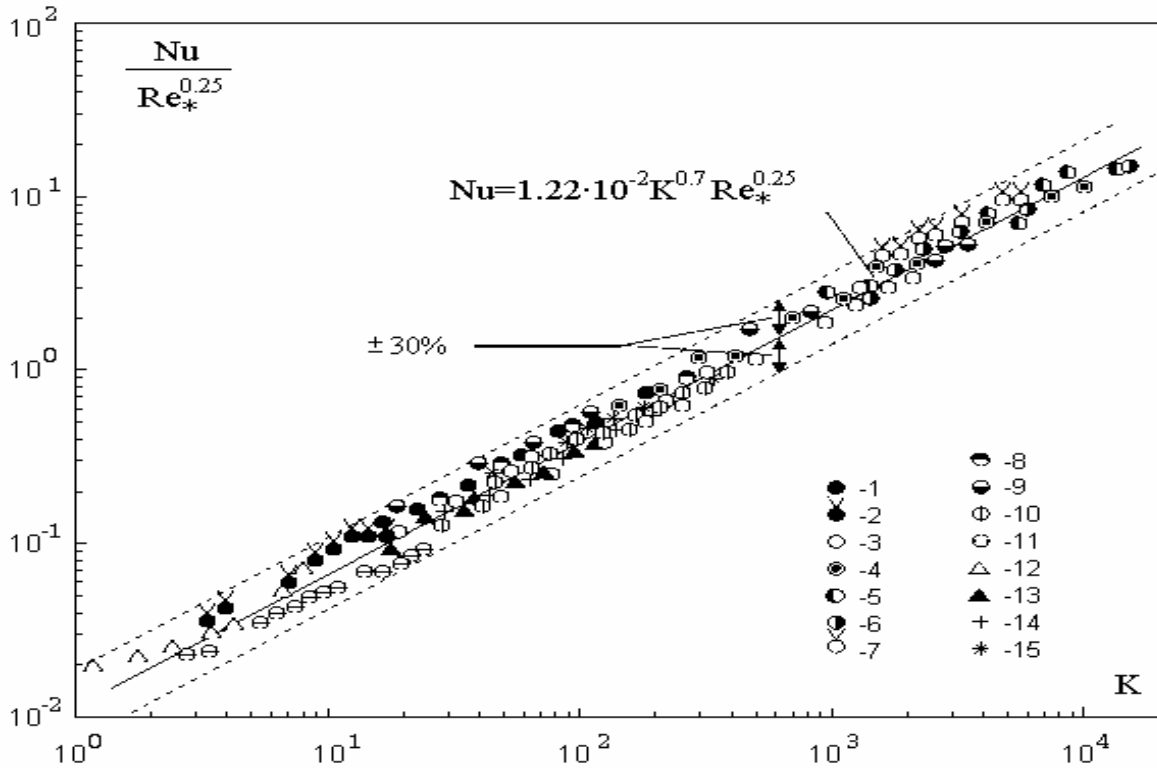

Figure 6. Correlation of experimental data on developed boiling of cryogenic liquids on commercial surfaces; nitrogen [22]: 1 - 0.1 MPa; nitrogen [92]: 2 - 0.1 MPa; 3 - 1.0 MPa; 4 - 2.0 MPa; 5 - 2.5 MPa; 6 - 3.0 MPa; 7 - 3.2 MPa; helium [101]: 8 - 0.1 MPa; 9 - 0.1 MPa; CO [22]: 10 - 0.45 MPa; NO [22]: 11 - 0.185 MPa; BF₃ [22]: 12 - 0.1 MPa; 13 - 0.57 MPa; 14 - 0.85 MPa; 15 - 1.25 MPa

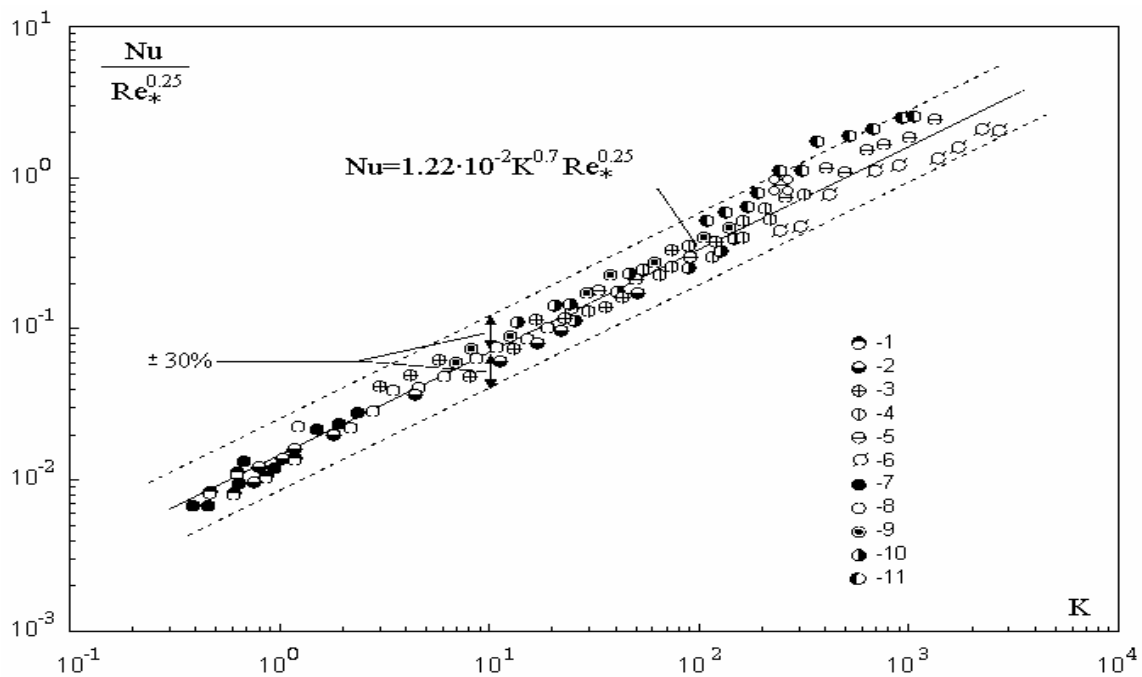

Figure 7. Correlation of experimental data on developed boiling of ethane [106] and ethylene [106] on commercial surfaces; ethane: 1 - 0.127 MPa; 2 - 0.49 MPa; 3 - 0.98 MPa; 4 - 1.47 MPa; 5 - 2.45 MPa; 6 - 2.94 MPa; ethylene: 7 - 0.127 MPa; 8 - 0.49 MPa; 9 - 0.98 MPa; 10 - 1.47 MPa; 11 - 2.45 MPa

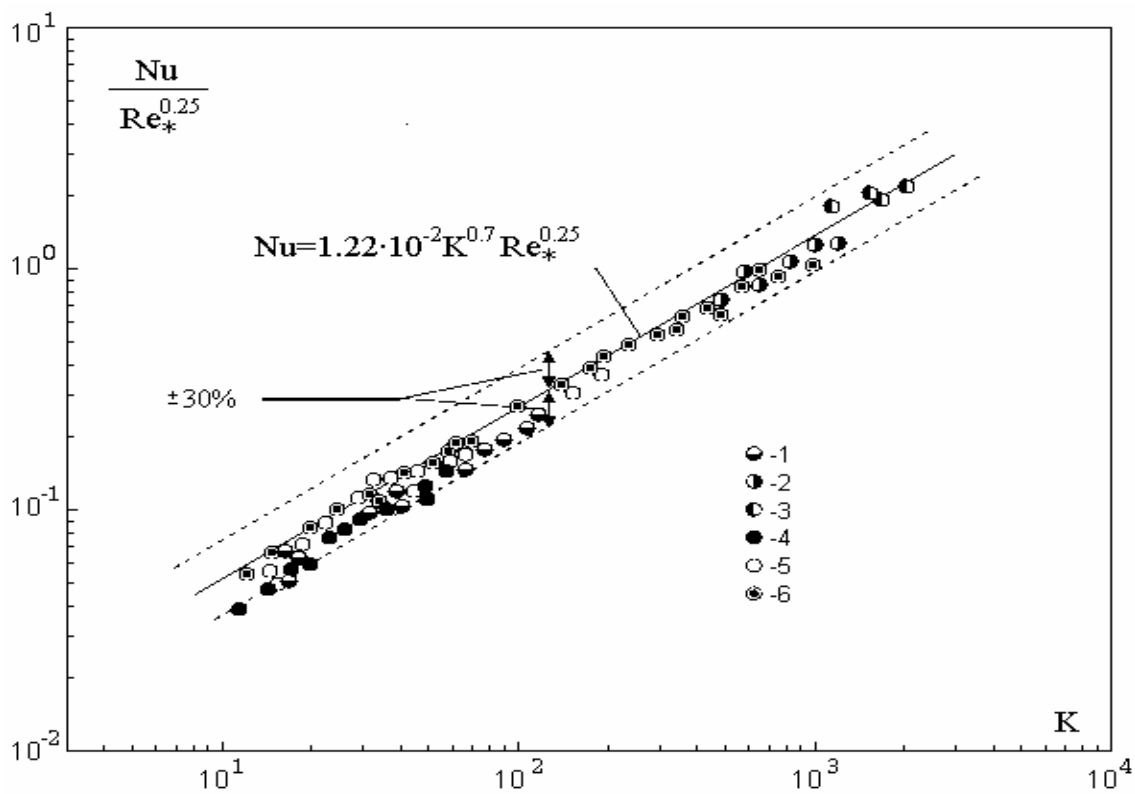

Figure 8. Correlation of experimental data on developed boiling of hydrogen and neon on commercial surfaces; hydrogen [101]: 1 - 0.082 MPa; 2 - 0.516 MPa; 3 - 0.85 MPa; neon [101]: 4 - 0.1 MPa; 5 - 0.2 MPa; 6 - 0.4 MPa